

Industrial Bar Code Scanners

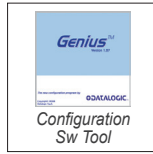

APPLICATIONS

- Postal/Courier parcel sorting and tracking
- Automated warehousing identification systems
- Airport baggage sorting systems
- Cargo applications
- Loading/unloading systems

ADVANTAGES

- Easily and rapidly configured thanks to Datalogic GENIUS™ (intuitive and multilanguage configuration program)
- DIGITECH™ Digitech technology permits full SW control over signal processing parameters. Scanner setup can therefore be optimized quite simply by loading the right SW recipe, thus enabling excellent performance in all reading conditions
- A simplified replacement procedure enables reduced down time due to automatic SW configuration restore in the new device
- Unbeatable reading performance and reliability on fast moving conveyor systems are ensured by ASTRA™ electronic focusing system (no mechanical moving parts)
- PackTrack™ function reduces the minimum object gap while enabling higher system throughput
- Fully compatible with DX8200A, 6000 series (DS6300, DS6400) and SC6000 industrial controller

HIGHLIGHTS

- Reading performance benchmark
- ACR4™ code reconstruction algorithm
- ASTRA™ technology for the electronic focusing system
- DIGITECH™ signal processing technology
- PACKTRACK™ to minimize the gap between objects and increase system productivity
- GENIUS™ multilanguage SW for easy scanner configuration/setup
- Display and keyboard
- Built-in Ethernet TCP/IP connectivity

GENERAL DESCRIPTION

DS8100A represents the evolution of a winning concept which started in 1998: the use of state-of-the-art technology to design the best performing fixed position scanner on the market. DS8100A is based on an innovative 3-diode structure that offers an unbeatable real time depth of field. Connectivity has been improved with the introduction of built-in Ethernet connectivity with implemented TCP-IP, Ethernet/IP and Modbus TCP protocols. A practical display with keyboard increases DS8100A ease of use by offering a simple and complete human machine interface without PC. The SW platform of the new DS8100A, based on GENIUS™ configuration program, permits 100% control of scanner functionality via SW. Moreover, DIGITECH™ technology enables excellent reading performance along the entire depth of field.

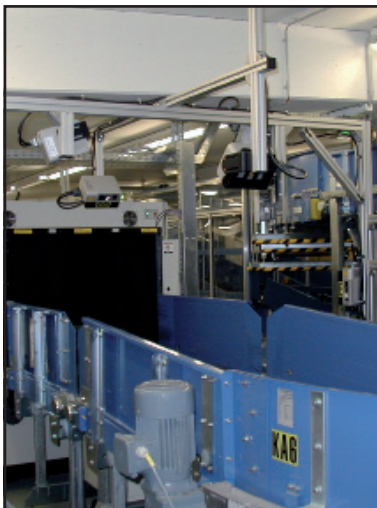

READING DIAGRAMS

DS8100A-2X10
0.50 mm/20 mils

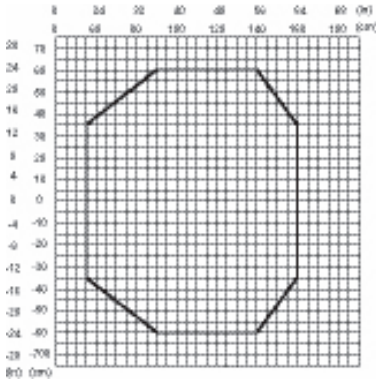

DS8100A-2X10
0.38 mm/15 mils

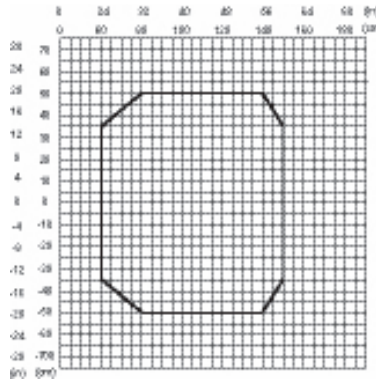

DS8100A-3X00
0.50 mm/20 mils

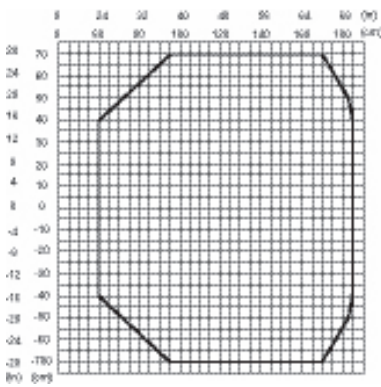

0.38 mm/15 mils

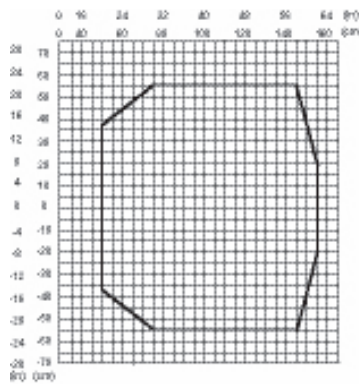

DS8100A-3X20
0.30 mm/12 mils

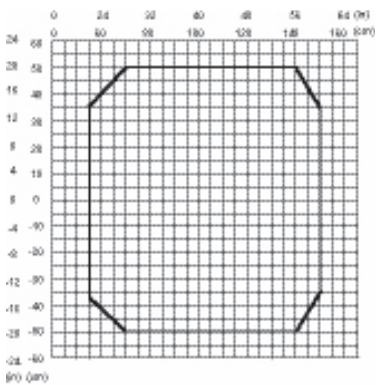

DS8100A-3X30
0.25 mm/10 mils

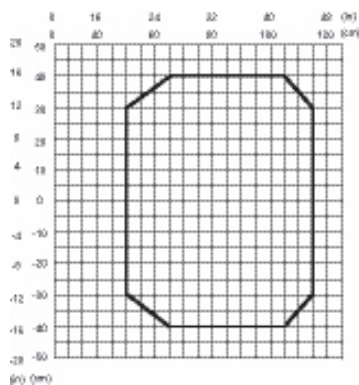

CONDITIONS

- Code = Interleaved 2/5 or Code 39
- PCS = 0.90
- "Pitch" angle = 0°
- "Skew" angle = 10°
- "Tilt" angle = 0°

READING DIAGRAMS

DS8100A-3X05
0.50 mm/20 mils

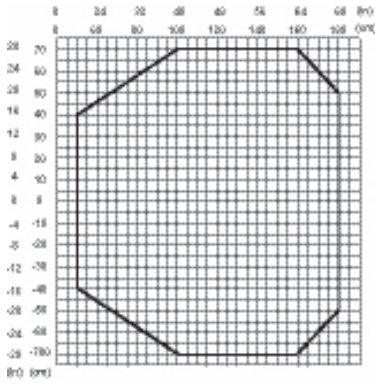

DS8100A-3X15
0.38 mm/15 mils

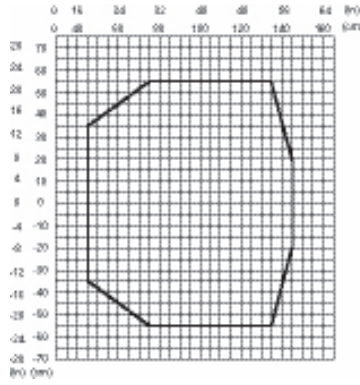

DS8100A-3X25
0.30 mm/12 mils

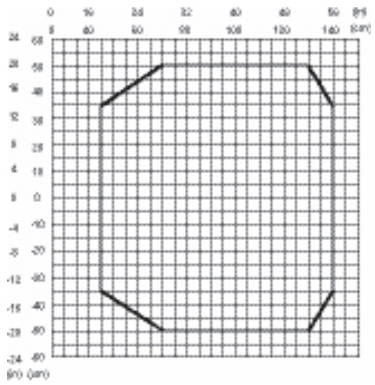

DS8100A-3X35
0.25 mm/10 mils

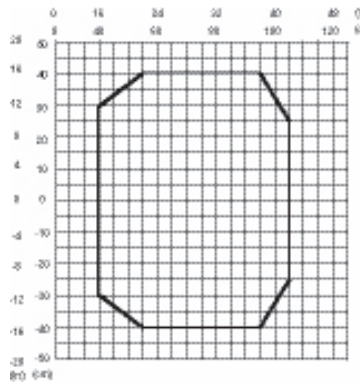

DIMENSIONS

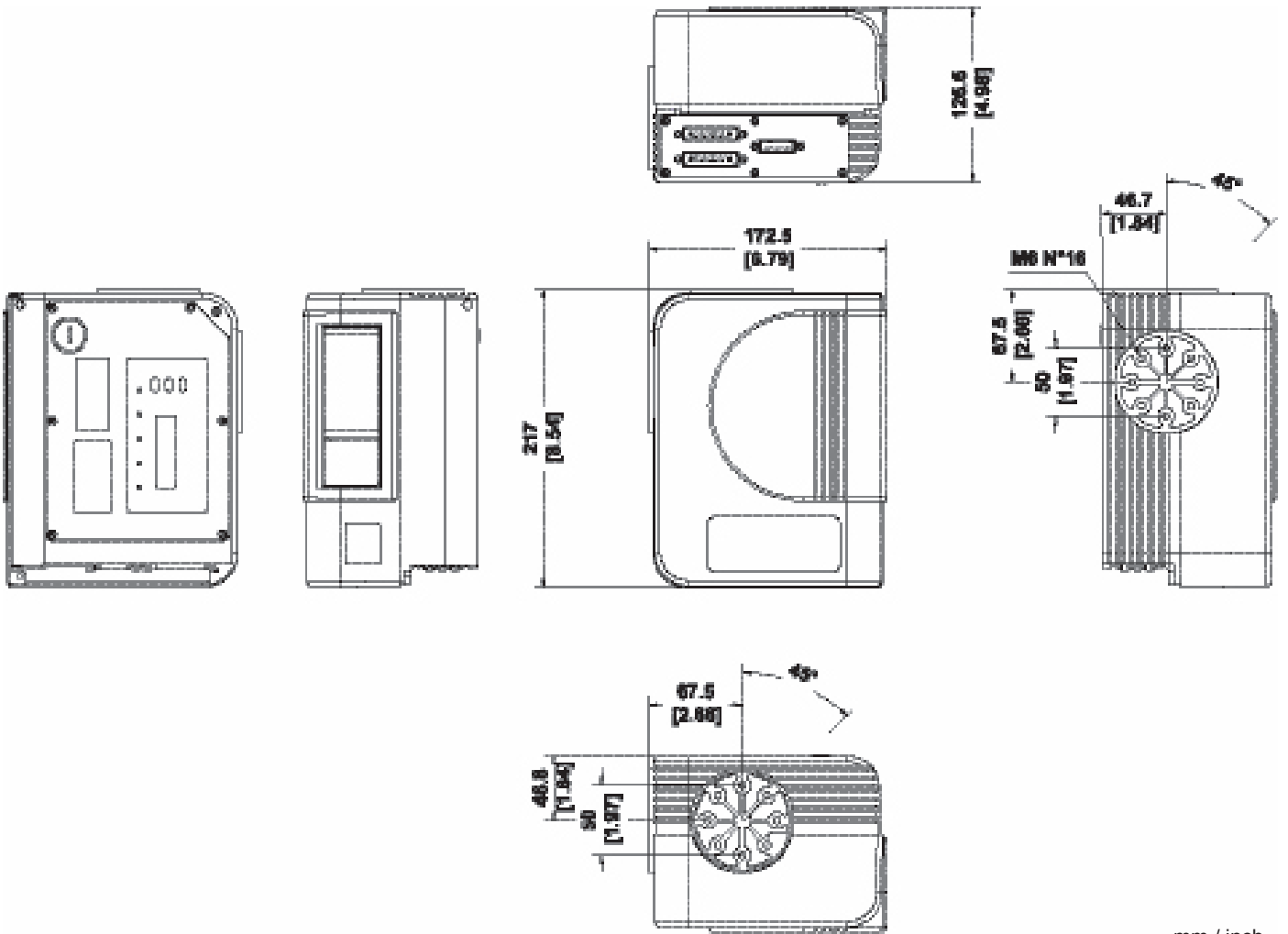

mm / inch

ELECTRICAL CONNECTIONS

All the connectors available for each DS8100A model are the following:

SCANNER MODEL	CONNECTORS
Standard	26-pin male serial interface and I/O connector 17-pin male Lonworks connector* 17-pin female Lonworks connector*
Ethernet	26-pin male serial interface and I/O connector 17-pin male Lonworks connector* 17-pin female Lonworks connector* RJ45 Industrial modular connector

The DS8100A Standard and Fieldbus models are equipped with a 26-pin male D-sub connector for connection to the host computer, power supply and input/output signals.

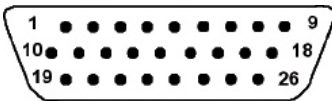

26-pin Connector

26-PIN D-SUB CONNECTOR PINOUT				
Pin	Name	Function		
1	CHASSIS	Chassis - internally connected to GND Cable shield connected to chassis		
20	RXAUX	Receive data of auxiliary RS232 (referred to GND)		
21	TXAUX	Transmit data of auxiliary RS232 (referred to GND)		
8	OUT 1+	Configurable digital output 1 - positive pin		
22	OUT 1-	Configurable digital output 1 - negative pin		
11	OUT 2+	Configurable digital output 2 - positive pin		
12	OUT 2-	Configurable digital output 2 - negative pin		
16	OUT 3A	Configurable digital output 3 - polarity insensitive		
17	OUT 3B	Configurable digital output 3 - polarity insensitive		
18	EXT_TRIG/PS A	External trigger (polarity insensitive) for PS		
19	EXT_TRIG/PS B	External trigger (polarity insensitive) for PS		
6	IN 2/ENC A	Input signal 2 (polarity insensitive) for Encoder		
10	IN 2/ENC B	Input signal 2 (polarity insensitive) for Encoder		
14	IN 3A	Input signal 3 (polarity insensitive)		
15	IN 4A	Input signal 4 (polarity insensitive)		
24	IN_REF	Common reference of IN3 and IN4 (polarity insensitive)		
9,13	VS	Supply voltage - positive pin		
23,25,26	GND	Supply voltage - negative pin		
Pin	RS232	RS232	RS485 Full-Duplex	RS485 Half-Duplex
2	Main Interface Signals (SW Selectable)	TX	TX485 +	RTX485 +
3		RX	RX485 +	
4		RTS	TX485 -	RTX485 -
5		CTS	RX485 -	
7		GND_ISO	GND_ISO	GND_ISO

ELECTRICAL CONNECTIONS

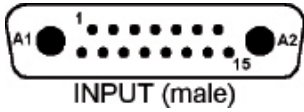

scanner side
external view

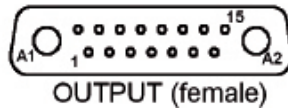

Lonworks INPUT/OUTPUT Connectors

LONWORKS INPUT/OUTPUT 17-PIN CONNECTOR PINOUT		
Pin	Name	Function
A1	GND	supply voltage (negative pin)
A2	VS	supply voltage 20 to 30 VDC (positive pin)
1	CHASSIS	Cable shield A – internally connected by capacitor to chassis
3	CHASSIS	Cable shield B – internally connected by capacitor to chassis
7	VS_I/O	Supply voltage of I/O circuit
8	LON A+	Lonworks a line (positive pin)
9	LON A-	Lonworks a line (negative pin)
10	LON B+	Lonworks b line (positive pin)
11	LON B-	Lonworks b line (negative pin)
12	SYS_I/O	System signal
13	SYS_ENC_I/O	System signal
14	RES	Internally connected
15	REF_I/O	Reference voltage of I/O circuit
2,4,5,6	NC	Not Connected



RJ45 Modular Jack

RJ45 MODULAR JACK PINOUT		
Pin	Name	Function
1	TX +	Transmitted data (+)
2	TX -	Transmitted data (-)
3	RX +	Received data (+)
6	RX -	Received data (-)
4,5,7,8	NC	Not connected

TECHNICAL DATA

DIMENSIONS	215.5 x 170.5 x 126.5 mm (8.48 x 6.71 x 4.98 in)	280 x 254 x 195 mm (11.03 x 10 x 7.68 in)
WEIGHT	5.0 Kg (176.3 oz.)	6.4 Kg (225.7 oz.)
CASE MATERIAL	Aluminum	
OPERATING TEMPERATURE	0 to 50 °C (32 to 122 °F)	
STORAGE TEMPERATURE	-20 to 70 °C (-4 to 158 °F)	
HUMIDITY	90% non condensing	
VIBRATION RESISTANCE	IEC 68-2-6 test FC 1.5mm; 10 to 55 Hz; 2 hours on each axis	
SHOCK RESISTANCE	IEC 68-2-27 test EA 30 G 11 ms; OM: 15 G 11 ms; 3 shocks on each axis	
PROTECTION CLASS	IP64 for standard models; IP65 on request	
LIGHT SOURCE	Visible laser diode (630 to 680 nm)	
SCANNING SPEED	1000 scans/s	
RESOLUTION	See diagrams	
READABLE SYMBOLOGIES	22 symbologies including 2/5 family, Code39, Code93, Code128, EAN/UPC, EAN128, ISBN128	
MULTILABEL READING	Up to 10 different symbologies during the same reading phase	
COMMUNICATION INTERFACES	Main Port: RS232/RS485 up to 115.2 Kbit/s	
	Auxiliary Port: RS232 up to 115.2 Kbit/s	
OTHER AVAILABLE INTERFACES	Lonworks (Master/Slave), Ethernet (optional)	
DIGITAL INPUTS	Three SW programmable and One "Encoder", optocoupled, NPN/PNP	
DIGITAL OUTPUTS	Three SW programmable, optocoupled, event driven	
DISPLAY & KEYPAD	LCD 16 x 2 characters & 3 keys	
LED INDICATORS	1) Power On (red) Good Read (red);	
	2) Trigger (yellow) TX Data (green); 3) Encoder (yellow) Network (red)	
DEVICE PROGRAMMING	Windows™ based SW (Genius™) via serial or Ethernet link	
	Serial Host Mode Programming sequences	
OPERATING MODES	'On-line', 'Serial On-line', 'Automatic', 'Continuous', 'PackTrack™', 'Test'	
LASER CLASSIFICATION	Class 2 - EN60825-1; Class II - CDRH	
LASER CONTROL	Safety system to turn laser off in cases of motor slowdown or failure	
POWER SUPPLY	20 to 30 VDC	
POWER CONSUMPTION	20 W typical, 30 W max	



APPLICATIONS

- Postal/Courier parcel sorting and tracking
- Automated warehousing identification systems
- Airport baggage sorting systems
- Cargo applications
- Loading/unloading systems

ADVANTAGES

- Improved connectivity thanks to the introduction of built-in Ethernet with implemented TCP-IP, Ethernet/IP and Modbus TCP protocols
- DIGITECH™ Digitech technology permits full SW control over signal processing parameters Scanner setup can therefore be optimized quite simply by loading the right SW recipe, thus enabling excellent performance in all reading conditions
- Ease of use is increased due to a practical display with keyboard, offering a simple and complete human machine interface without PC
- Fully compatible with the DS8100A, the 6000 series (DS6300, DS6400) and the SC6000 industrial controller