

DENSO

Bar Code Handy Scanner

GT10B-SB

GT10B-LB

User's Manual

-
- DENSO WAVE INCORPORATED does not assume any product liability arising out of, or in connection with, the application or use of any product, circuit, or application described herein.
 - If it is judged by DENSO WAVE INCORPORATED that malfunction of the product is due to the product having been dropped or subjected to impact, repairs will be made at a reasonable charge even within the warranty period.
 - Intellectual Property Precaution

DENSO WAVE INCORPORATED ("DENSO WAVE") takes reasonable precautions to ensure its products do not infringe upon any patent or other intellectual property rights of other(s), but DENSO WAVE cannot be responsible for any patent or other intellectual property right infringement(s) or violation(s) which arise from (i) the use of DENSO WAVE's product(s) in connection or in combination with other component(s), product(s), data processing system(s) or equipment or software not supplied from DENSO WAVE; (ii) the use of DENSO WAVE's products in a manner for which the same were not intended nor designed; or (iii) any modification of DENSO WAVE's products by other(s) than DENSO WAVE.

- Limited Warranty on Software Products

In no event will DENSO WAVE be liable for direct, indirect, special, incidental, or consequential damages (including imaginary profits or damages resulting from interruption of operation or loss of business information) resulting from any defect in the software or its documentation or resulting from inability to apply the software or its documentation.

Bluetooth® is a trademark owned by its proprietor. DENSO WAVE uses Bluetooth® wireless technology under license.

Copyright © DENSO WAVE INCORPORATED, 2008, 2007, 2005, 2004

All rights reserved. No part of this publication may be reproduced in any form or by any means without permission in writing from the publisher.

All products and company names mentioned in this manual are trademarks or registered trademarks of their respective holders.

Specifications are subject to change without prior notice.

FCC and RSS-210 Regulations

This device complies with Part 15 of the FCC Rules. Operation is subject to the following two conditions:

This device complies with Part 15 of the FCC Rules and RSS-210 Rules

Operation is subject to the following two conditions:

- (1) this device may not cause harmful interference, and
- (2) this device must accept any interference received, including interference that may cause undesired operation.

FCC WARNING: Changes or modifications not expressly approved by the party responsible for compliance could void the user's authority to operate the equipment.

NOTE: This equipment has been tested and found to comply with the limits for a Class B digital device, pursuant to part 15 of the FCC Rules. These limits are designed to provide reasonable protection against harmful interference in a residential installation. This equipment generates, uses and can radiate radio frequency energy and, if not installed and used in accordance with the instructions, may cause harmful interference to radio communications. However, there is no guarantee that interference will not occur in a particular installation. If this equipment does cause harmful interference to radio or television reception, which can be determined by turning the equipment off and on, the user is encouraged to try to correct the interference by one or more of the following measures:

- Reorient or relocate the receiving antenna.
- Increase the separation between the equipment and receiver.
- Connect the equipment into an outlet on a circuit different from that to which the receiver is connected.
- Consult the dealer or an experienced radio/TV technician for help.

Caution: Radio Frequency Exposure

This device meets the FCC RF Exposure Guidelines in OET65.

This transmitter and its antenna should not be placed next to other antennas or similar radiating structure.

ICES-003 Regulation

This Class B digital apparatus complies with Canadian ICES-003.

Cet appareil numérique de la classe B est conforme à la norme NMB-003 du Canada.

The radio frequency module that complies with the Directive 99/5/EC (R&TTE) is mounted on this device (GT10B-SB/LB).

DECLARATION OF CONFORMITY
Directive 99/5/EC (R&TTE)

Manufacturer or Authorized representative :

- Name : **DENSO WAVE INCORPORATED**
- Address : **1-1, Showa-cho, Kariya-shi, Aichi-ken, 448-8661, Japan**

Description product :

- Product name : **Bluetooth Board**
- Product model Number : **DWBT002**

Essential Requirement and Harmonized Standards applied

- Health and safety requirements pursuant to 3 (1) a:
Applied Standard(s) or other means of providing conformity: **EN60950**

- Protection requirements concerning EMC §3 (1) b:
Applied Standard(s) or other means of providing conformity: **EN301 489-1 V1.6.1**
EN301 489-17 V1.2.1

- Measures for the effective use of the Radio frequency spectrum §3 (2):
Applied Standard(s) or other means of providing conformity: **EN300 328 V1.7.1**

CE Marking ;



Contents

Preface	i
SAFETY PRECAUTIONS.....	ii
Components Required	viii
Bluetooth® Wireless Communication Link	ix
Care and Maintenance	x
Chapter 1 Part Names and Functions	1
Chapter 2 Bluetooth® Interface	2
2.1 Enabling Bluetooth® Interface	2
2.2 Establishing Bluetooth® Wireless Link	3
2.3 Breaking Bluetooth® Wireless Links	6
2.4 Reestablishing Bluetooth® Wireless Links	6
2.5 Indication of Bluetooth® Wireless Link Status	7
Chapter 3 Reading Bar Codes	8
Chapter 4 Customizing the Scanner	11
Chapter 5 Scanning Control	12
5.1 Trigger Switch Control	12
5.2 Software Control	13
5.3 Auto Sensing Mode—Automatic Detection of Labels	15
5.4 Reading with Scanner Mounted on Charger	16
Chapter 6 Magic Key Control	17
Chapter 7 Scanning Functions.....	19
7.1 Data Verification Mode	19
7.1.1 Verification setup procedure	19
7.1.2 Verification conditions	21
7.1.3 Verification result output.....	22
7.1.4 Output of the master data registered.....	23
7.1.5 Breaking the Bluetooth® wireless link with no master data registered.....	23
7.2 Specifying the Numbers of Digits of Standard 2of5 and Interleaved 2of5 Symbols to Read, by Scanning Bar Codes	24
Chapter 8 Data Editing	25
8.1 Extracting Data	25
8.2 Substituting Data	26
8.3 Blocksoring Data	27
8.4 Parenthesizing AIs (Application Identifier) in EAN-128 Data	28
8.5 Extracting AI (Application Identifier)-Prefixed Strings from EAN-128 Data.....	28
8.6 Data Editing Notes	29
8.6.1 Data edit conditions	29

8.6.2	Rules for data editing.....	29
8.6.3	AI table	30
Chapter 9	Beeper, Indicator LED and Vibrator	35
9.1	Beeper.....	35
9.2	Indicator LED.....	37
9.3	Vibrator	38
Chapter 10	Communication.....	39
10.1	Bluetooth® Interface.....	39
10.2	Communication Format.....	40
10.2.1	Data transmission format.....	40
10.2.2	GTIN format conversion	44
10.3	Data Packaging (Packetizing).....	45
Chapter 11	Charging and Replacing the Battery Cartridge	48
11.1	Charging and Discharging the Battery Cartridge	48
11.2	Replacing the Battery Cartridge.....	50
11.3	Recycling the Battery Cartridge.....	52
Chapter 12	Parameters and Defaults	53
(1)	Bluetooth® communications parameters	53
(2)	Data transmission format and bar code symbologies.....	54
(3)	Trigger switch control and magic key control.....	59
(4)	Beeper, indicator LED and vibrator	60
(5)	Data verification mode	61
(6)	Notification of a scanning failure under software control	61
(7)	Speed-/depth-priority scanning	62
(8)	Switching to sleep mode for power saving	62
(9)	For Bluetooth® adapter: Bluetooth® communications parameters.....	63
(10)	For Bluetooth® adapter: Interfaces	63
(11)	For Bluetooth® adapter: USB keyboard interface communications parameters.....	63
(12)	For Bluetooth® adapter: USB-COM interface communications parameters	65
(13)	For Bluetooth® adapter: RS-232C interface communications parameters.....	65
(14)	For Bluetooth® adapter: PS/2 keyboard interface communications parameters	66
(15)	For Bluetooth® adapter: Substitution of header/terminator for PS/2 and USB keyboard interfaces.....	68
Chapter 13	Bar-Coded Parameter Menu for Scanners.....	69
13.1	Parameter Setting Procedure Using the Bar-Coded Parameter Menu.....	69
13.2	Bar-Coded Parameter Menu for Scanners	70
■	Starting/ending the setting procedure and reverting to defaults.....	71
■	Bluetooth® interface communications parameters.....	72
■	Data transmission format and bar code symbologies	74
■	Trigger switch control and magic key control	84
■	Beeper, indicator LED and vibrator.....	85

	■ Data verification mode	86
	■ Notification of a scanning failure under software control	88
	■ Reading with scanner mounted on charger	89
Chapter 14	Bar-Coded Parameter Menu for Bluetooth® Adapters (BA10-RKU).....	90
14.1	Configuring the Bluetooth® Adapter from the Scanner	90
14.2	Bar-Coded Parameter Menu for Bluetooth® Adapters	92
	■ Starting and ending the setting procedure, and restoring to defaults	92
	■ Setting the interface.....	92
	■ Bluetooth® interface communications parameters	93
	■ USB keyboard interface communications parameters	94
	■ USB-COM interface communications parameters	96
	■ RS-232C interface communications parameters.....	97
	■ PS/2 keyboard interface communications parameters	99
Chapter 15	Troubleshooting.....	101
Appendix 1	Specifications.....	103
Appendix 2	Bar Code Sample Label.....	106
Appendix 3	Bluetooth® Glossary	108
Appendix 4	Pairing (Device authentication).....	109
Appendix 5	Quick Setup for the Use of USB Keyboard Interface.....	111
Appendix 6	Quick Setup for the Use of USB-COM Interface	114
Appendix 7	Quick Setup for the Use of RS-232C Interface.....	119
Appendix 8	Quick Setup for the Use of PS/2 Keyboard Interface.....	123

Preface

This user's manual sets forth the procedures for handling, connecting, operating, and cleaning your bar code handy scanner. Before you do anything else, study it carefully to make sure that you use the product both correctly and effectively. Also keep it handy for ready reference.

SAFETY PRECAUTIONS

Be sure to observe all these safety precautions.

- Please READ through these instructions carefully. They will enable you to use the scanner correctly.
- Always keep this manual nearby for speedy reference.

Strict observance of these warnings and cautions is a MUST for preventing accidents that could result in bodily injury and substantial property damage. Make sure you fully understand all definitions of these terms and symbols given below before you proceed to the text itself.



WARNING

Alerts you to those conditions that could cause serious bodily injury or death if the instructions are not followed correctly.



CAUTION

Alerts you to those conditions that could cause minor bodily injury or substantial property damage if the instructions are not followed correctly.

Meaning of Symbols



A triangle (Δ) with a picture inside alerts you to a warning of danger. Here you see the warning for electrical shock.



A diagonal line through a circle (\odot) warns you of something you should not do; it may or may not have a picture inside. Here you see a screwdriver inside the circle, meaning that you should not disassemble.



A black circle (\bullet) with a picture inside alerts you to something you MUST do. This example shows that you MUST unplug the power cord.

 **WARNING**



To System Designers:

- When introducing the scanner in those systems that could affect human lives (e.g., medicines management system), develop applications carefully through redundancy and safety design which avoids the feasibility of affecting human lives even if a data error occurs.

Handling the battery cartridge

Wrong handling of the battery cartridge could result in a heat, smoke, explosion, or fire. Be sure to observe the following.



- Never disassemble or heat the battery cartridge, nor put it into fire or water; doing so could cause battery-rupture or leakage of battery fluid, resulting in a fire or bodily injury.
- Do not carry or store the battery cartridge together with metallic ballpoint pens, necklaces, coins, hairpins, etc.
Doing so could short-circuit the terminal pins, causing the batteries to rupture or the battery fluid to leak, resulting in a fire or bodily injury.
- Never put the battery cartridge into a microwave oven or high-pressure container.
Doing so could cause the batteries to break, generate heat, rupture or burn.
- Avoid dropping the battery cartridge or letting it undergo any shock or impact.
Doing so could cause the batteries to break, generate heat, rupture or burn.
- Never charge the battery cartridge where any inflammable gases may be emitted; doing so could cause fire.
- If any abnormality is detected--smoking, abnormal odors, discoloration or deformation when the battery cartridge is in use, in storage or being charged, remove the battery cartridge from the scanner or charger.



- Only use the dedicated charger for charging the battery cartridge.
Using a different type of charger could cause battery-rupture or leakage of battery fluid and result in a fire, bodily injury, or serious damage to property.
- The battery cartridge contains strong alkaline liquid (electrolyte).
If battery liquid leaks from the battery cartridge and it gets into your eyes, rinse them with clean water thoroughly without rubbing and consult a doctor as soon as possible. Otherwise, you may damage your eyes.

WARNING

Handling the scanner

Wrong handling of the scanner could result in a scanner failure, heat, or smoke. Be sure to observe the following.



- If using the hand strap or neck strap, exercise due care to avoid getting them caught in other objects or entangled in rotating machinery. Failure to do so could result in accident or injury.



- Never use the scanner on the line voltage other than the specified level.
Doing so could cause the charger to break or burn.
- Do not use the scanner where any inflammable gases may be emitted.
Doing so could cause fire.
- Do not subject the scanning window of the scanner to direct sunlight for extended periods.
Doing so could damage the scanner, resulting in a fire.
- Never bring any metals into contact with the terminals in connectors.
Doing so could produce a large current through the scanner, resulting in heat or fire, as well as damage to the scanner.
- Never put the battery cartridge into a microwave oven or high-pressure container.



- If smoke, abnormal odors or noises come from the scanner, immediately remove the battery cartridge and contact your nearest dealer.
Failure to do so could cause fire or electrical shock.
- If foreign material or water gets into the scanner, immediately remove the battery cartridge and contact your nearest dealer.
Failure to do so could cause fire or electrical shock.
- If you drop the scanner so as to affect the operation or damage its housing, remove the battery cartridge and contact your nearest dealer.
Failure to do so could cause fire or electrical shock.
- Stop charging if it cannot be completed within the specified time.
- The battery cartridge contains strong alkaline liquid (electrolyte).
If the liquid leaked out of the battery adheres to the skin or clothes, immediately flush it with running water. The alkaline liquid could cause the skin irritation.
- Use the dedicated battery cartridge only.
Failure to do so could result in fire.

 **WARNING**

Handling the AC adapter

Wrong handling of the AC adapter could result in a failure, heat, or smoke. Be sure to observe the following.



- Do not scratch, modify, bend, twist, pull, or heat the AC adapter cable. Do not place heavy material on the cable or allow the cable to get pressed under heavy material.
Doing so could break the cable, resulting in a fire.



- Keep the AC adapter away from water.
Failure to do so could cause fire or electrical shock.
- If the AC adapter cable is damaged (e.g., exposed or broken lead wires), stop using it and contact your nearest dealer.
Failure to do so could result in a fire or electrical shock.

CAUTION

Handling the scanner and AC adapter

Wrong handling of the scanner or AC adapter could result in a failure, heat, or smoke. Be sure to observe the following.



Never disassemble

- Never disassemble or modify the scanner or AC adapter; doing so could result in an accident such as break or fire.
Doing so could result in a fire or electrical shock.



- Do not put the scanner or AC adapter on an unstable or inclined plane.
It may drop, creating injuries.
- Never put the scanner or AC adapter in places where there are excessively high temperatures, such as inside closed-up automobiles, or in places exposed to direct sunlight.
Doing so could affect the housing or parts, resulting in a fire.
- Avoid using the scanner or AC adapter in extremely humid areas, or where there are drastic temperature changes.
Moisture will get into the scanner or AC adapter, resulting in malfunction, fire or electrical shock.
- Do not place the scanner or AC adapter anywhere where it may be subjected to oily smoke or steam, e.g., near a cooking range or humidifier.
Doing so could result in a fire or electrical shock.
- Never cover or wrap up the scanner or AC adapter in a cloth or blanket.
Doing so could cause the scanner or AC adapter to heat up inside, deforming its housing, resulting in a fire.
Always use the scanner or AC adapter in a well-ventilated area.
- Do not insert or drop foreign materials such as metals or anything inflammable through the openings (vents or scanning window) into the scanner.
Doing so could result in a fire or electrical shock.
- Do not scratch or modify the scanner or AC adapter.
Doing so could damage the scanner or AC adapter, creating a fire hazard.
- Do not put heavy material on the scanner or its interface cable, or allow the cable to get pressed under heavy material.
- Do not look into the light source from the scanning window or do not point the scanning window at other people's eyes.
Eyesight may be damaged by direct exposure to this light.
- Do not use the scanner or AC adapter if your hands are wet or damp.
Doing so could result in an electrical shock.
- Never use chemicals or organic solvents such as benzene and thinner to clean the housing. Do not apply insecticide to the scanner or AC adapter.
Doing so could result in a marred or cracked housing, electrical shock or fire.
- Do not use the scanner with anti-slip gloves containing plasticizer.
The scanner housing may be broken, creating injuries, electrical shock, or fire.

 **CAUTION**



- If you are not using the scanner for a long time, be sure to remove the battery cartridge for safety.
Failure to do so could result in a fire.
- When unplugging the AC adapter from the electrical outlet, hold the connector housing not the cable.
The AC adapter cable may be broken, resulting in a burnt AC adapter, electrical shock, or fire.



- When taking care of the scanner, remove the battery cartridge. When taking care of the AC adapter, unplug it from the electrical outlet for safety.
Failure to do so could result in an electrical shock.
- Do not drop the scanner or AC adapter.
The housing may be broken, creating injuries. Using the scanner or AC adapter whose housing is broken could result in smoke or fire.
Remove the battery cartridge from the scanner.
Unplug the AC adapter from the electrical outlet.
Then contact your nearest dealer.
- During electrical storm activity, unplug the AC adapter from the electrical outlet.
Exposure to power surges could result in a damaged charger or fire.

Components Required

The scanner GT10B-SB/LB requires the following components that differ depending upon whether the Bluetooth® adapter is used and which interface is selected.

■ When using the Bluetooth® adapter (BA10-RKU)

Basic components

The table below lists the basic components required for the use of the Bluetooth® adapter.

(1) Scanner	GT10B-SB/LB	
(2) Bluetooth® adapter	BA10-RKU	
(3) Charger	CH-GT10N	
(4) AC adapter	AD2-2005/3000 (USA) AD2-3005/3000 (EU)	For charger

Components required for individual interfaces

- For RS-232C interface

(5) RS-232C interface cable	CBBA-RS2000/9	
(6) AC adapter	AD2-2005/3000 (USA) AD2-3005/3000 (EU)	For Bluetooth® adapter

- For RS-232C interface and Bluetooth® adapter mounted in the charger

(5) RS-232C interface cable, Charger built-in type	CBBA-RS2000/9-1	
---	-----------------	--

- For PS/2 keyboard interface

(5) PS/2 keyboard interface cable	CBBA-KYS2000/6	
-----------------------------------	----------------	--

- For USB keyboard or USB-COM interface

(5) USB interface cable	CBBA-US2000/4	
-------------------------	---------------	--

■ When directly communicating with Bluetooth®-enabled equipment (no BA10-RKU Bluetooth® adapter is used)

(1) Scanner	GT10B-SB/LB	
(2) Charger	CH-GT10N	
(3) AC adapter	AD2-2005/3000 (USA) AD2-3005/3000 (EU)	For charger

Bluetooth® Wireless Communication Link

The scanner GT10B-SB/LB uses Bluetooth® wireless networking technology.

Item	Specifications
Standard	Bluetooth® Specification Ver. 1.1
Radio output	Class 2 (maximum 2.5 mW)
Profile(s) supported	Serial port profile
Communications range (reference value*1)	Max. 10 m, with no obstructions

*1 This value is for wireless networking between the scanner and the BA10-RKU Bluetooth® adapter. The communications range varies with the equipment used and the operating environment.

Wireless networking requires a stable radio environment. Not all operating environments provide this. In particular, note that

- Using the scanner in close proximity to other wireless LAN equipment operating in the same frequency band (2.4 GHz) risks radio interference that can reduce throughput or even entirely block wireless networking.
- Microwave ovens, industrial heating equipment, high-frequency medical equipment, and other equipment using the 2.4 GHz band can sometimes block wireless networking.
- Electromagnetic noise from computers, refrigerators, and other home appliances can sometimes block wireless networking.
- The following environments can sometimes block wireless networking.
 - Metal objects or particles in the vicinity
 - Metal walls around the area
 - Excessive vibration
- The communications range of 10 m given above is merely a reference value assuming a clear line of sight. Reliable wireless networking is by no means guaranteed at 10 m for all combinations of equipment used and operating environments. Some combinations might even work for greater distances, but be sure to confirm that the scanner link operates properly before introducing the link operation.

NOTE: To System Designers:

- Before developing applications, make sure that the intended environment is free of the interference factors above and thus actually capable of supporting link operation.
- When introducing the scanner into an environment where equipment using radio waves in the 2.4 GHz band operates or when introducing such equipment after the introduction of the scanner, be sure to confirm that the scanner radio link operates properly with all equipment being in operation beforehand.
- If the environment of the radio communications system is changed after the introduction (e.g., newly installed household appliances and movement/addition of shelves or objects), then confirm that the radio link operates properly again before the actual use.

Care and Maintenance

Dust and other foreign matter on the clear plate of the reading window can impede bar code input, so regularly check for it and remove it as the usage environment warrants.

- To clean the plate, first blow the dust away with an airbrush. Then gently wipe the plate with a cotton swab or the similar soft one.
- If sand or hard particles have accumulated, never rub the plate; doing so will scratch or damage it. Blow the particles away with an airbrush or a soft brush.

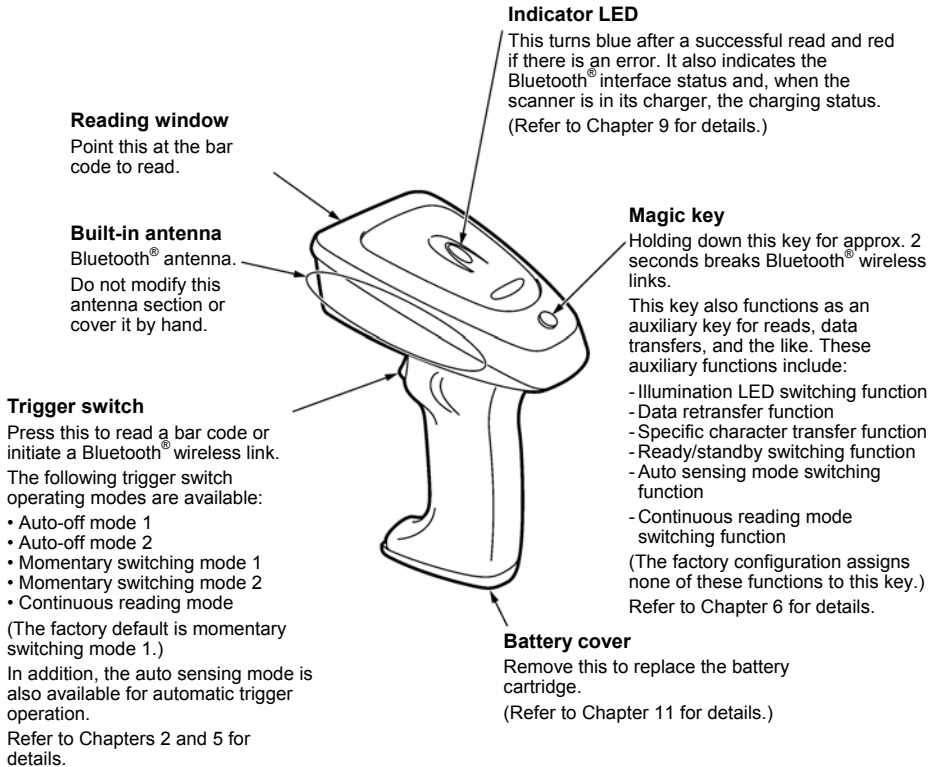

Chapter 2 Bluetooth® Interface

For terms relating to Bluetooth® wireless communication in this manual, refer to Appendix 3 "Bluetooth® Glossary."

2.1 Enabling Bluetooth® Interface

Using the scanner for the first time or any other time that the "End operation" is selected requires scanning the following "Start operation" bar code to start operation. Scanning it enables the Bluetooth® interface.



Start operation

Note: Always disable this scanner's Bluetooth® interface in hospitals, aircraft, and other environments where the Bluetooth® radio waves (2400 MHz to 2483.5 MHz, maximum 2.5 mW) present a potential safety risk.

This scanner interprets the following bar code as a command to disable the Bluetooth® interface.



End operation

Note: When the scanner leaves the factory or it has scanned the "End operation" bar code, it cannot read bar codes except the "Start operation" bar code.

2.2 Establishing Bluetooth® Wireless Link

After enabling the Bluetooth® interface, establish a Bluetooth® wireless link between the scanner and the BA10-RKU Bluetooth® adapter (or some other Bluetooth® equipment) using the following procedures. The scanner can act as both a master and slave (default).

A scanner configured and connected as a master remembers previous target devices, so, even if the link is broken, pressing the scanner trigger switch is all that it takes to reconnect.

Scanner as Master

■ Using the Bluetooth® adapter

- (1) Use the scanner to read the bar code on the back of the Bluetooth® adapter.

The scanner configures itself as a master and establishes a Bluetooth® wireless link with the Bluetooth® adapter.

Even if the scanner has been configured as a slave, reading this bar code initiates connection as a master.

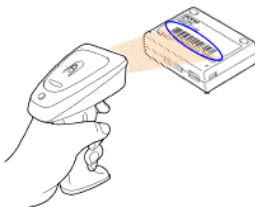

- (2) Wait for the scanner to beep twice and the indicator LED to turn green (for 0.5 second).

■ Using some other Bluetooth® device

To configure the scanner as a master and some other Bluetooth® equipment as a slave, follow the sample procedures given below and specify the slave's Bluetooth® address to the scanner. The connection ratio of the scanner and slave device should be 1:1.

- (1) Confirm the device's Bluetooth® address.

For the instructions on how to confirm, see the user's manual.

- (2) Create a "Bluetooth® address" bar code for the Bluetooth® address thus obtained.

- The following is the procedure for configuration software (ScannerSetting)* versions 2.4.0 and later.

- 1) Run the configuration software on your computer.

- 2) On the Options screen, select GT10B SB as the product name and press the Offline button. (Shown below is a screen in configuration software version 2.5.0.)

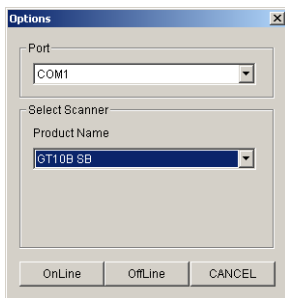

* Registered users can download the configuration software (ScannerSetting) from QBdirect, their customer support section on the Denso Wave website at no extra charge.

For further details on QBdirect or to register, visit the following URL.

<http://www.qbdirect.net>

3) Select an arbitrary version and press the OK button.

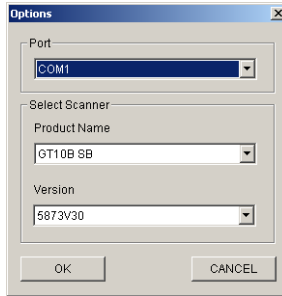

4) On the Bluetooth® window shown below, select "Connect to optional Bluetooth device" as the Connection method, "Master" as the Mode, "Address" as the Access point. In the text box, enter the Bluetooth® address obtained in step (1) above.

5) Press the Print Connect Label button.

Pressing the Preview button displays the "Bluetooth® address" bar code created. The displayed bar code can be read with the scanner.

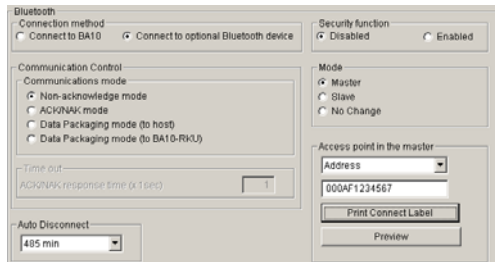

6) On the window shown below, press the Print button to print the bar code.

Alternatively, press the Copy button to copy the bar code to the Windows Clipboard as bit map data (.bmp) for pasting into an image editor, word processor, or other application accepting that format.

(Optional) In the Comment text box, enter any desired descriptive text to print with the bar code.

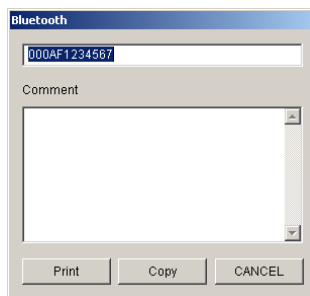

- When using a commercially available bar code generator, generate it in the following format.

Bar code type	Code 128, Code set A
Value	ADDR followed by Bluetooth® address (in hexadecimal)

(Example) Bluetooth® address 000AF1234567



- (3) Use the scanner to read the "Bluetooth® address" bar code created in step (2) above.

The scanner as a master initiates connection to the specified Bluetooth® device, switching the scanner from the slave configuration first, if necessary.

- (4) Wait for the scanner to beep twice and the indicator LED to turn green (for 0.5 second), indicating a successful connection.

Note: The scanner supports Bluetooth® pairing (authentication using pass keys) when connecting to slave devices. For further details, first see Appendix 4 and then refer to the user's manual for the target device.

Scanner as Slave (default)

The scanner is a slave by default. This slave can establish a Bluetooth® wireless link with the BA10-RKU Bluetooth® adapter (or some other Bluetooth® equipment) as a master without special communication procedures.

- (1) If the scanner is currently a master, read the following bar code to switch it to slave operation.



Configure as slave

- (2) Wait for the scanner to beep three times, press the scanner's trigger switch, and wait approximately two minutes (default) for the master device to connect to this slave.
- (3) Configure the Bluetooth® adapter (or some other Bluetooth® equipment) as a master and specify the scanner's Bluetooth® address.

For the Bluetooth® adapter, use the configuration software (BASetting). (For other Bluetooth® equipment, use the procedures set forth in the user's manual.)

- (4) Wait for the Bluetooth® adapter (or some other Bluetooth® equipment) to establish a Bluetooth® wireless link with the scanner as a slave.
- (5) Wait for the scanner to beep twice and the indicator LED to turn green (for 0.5 second), indicating a successful connection.

Note: If a search by a master device finds no scanners within effective range, increase the scanner connection timeout interval for slave operation and try again.

Note: The scanner also supports Bluetooth® pairing (authentication using pass keys) when connecting to master devices. For further details, first see Appendix 4 and then refer to the user's manual for the target device.

2.3 Breaking Bluetooth® Wireless Links

Holding down the magic key in the regular read mode breaks the scanner's Bluetooth® wireless link.

Scanning the following bar code forcibly breaks the scanner's Bluetooth® wireless link.



Break Bluetooth® wireless link

Note: Breaking the Bluetooth® wireless link does not disable the Bluetooth® interface. To disable it, scan the "Stop operation" bar code.

Note: In the data verification mode, the magic key is used to register master data, not used to break the Bluetooth® wireless link. To break the link, use the scanner to read the "Break Bluetooth® wireless link" bar code. Note that when the scanner, as a master, is searching for a connection target or it is, as a slave, waiting for a master to connect, the magic key can break the Bluetooth® wireless link.

2.4 Reestablishing Bluetooth® Wireless Links

When the scanner's Bluetooth® wireless link has been broken by any of the following events, pressing the trigger switch reestablishes the Bluetooth® wireless link. The scanner as a slave waits for a connection request from the master; the scanner as a master reconnects to a target slave.

- Scanning the "Start operation" bar code
- Scanning the "Break Bluetooth® wireless link" bar code
- Pressing the magic key to break the Bluetooth® wireless link
- Customizing the scanner with the configuration software (ScannerSetting)
- "Reconnect request" dialog being displayed by the configuration software (ScannerSetting)
- Replacing the battery cartridge
- Failure to automatically reconnect within the specified time

If the Bluetooth® wireless link breaks for some reason other than the above--degraded radio wave conditions, or loss of power to the Bluetooth® adapter, commercially available Bluetooth® device, or other target device, for example--the scanner automatically tries to reconnect for approximately 40 seconds for master operation or for the user-specified connection timeout interval for slave operation.

2.5 Indication of Bluetooth® Wireless Link Status

The scanner's indicator LED and beeper together indicate the status of the scanner's Bluetooth® wireless link.

When the trigger switch is held down:

Indicator LED	Beeper	Scanner Status
Red, blinking	Silent	Reading is not possible when there is no Bluetooth® wireless link.
Red, blinking twice repeatedly		The scanner has scanned the "End operation" bar code.

When the trigger switch is pressed and released:

Indicator LED	Beeper	Scanner Status
Blue, blinking rapidly	Silent	The scanner, as a master, is searching for a connection target.
Blue, blinking slowly		The scanner, as a slave, is waiting for a master to connect.

When the Bluetooth® wireless link is established or broken:

Indicator LED	Beeper	Scanner Status
Green for 0.5 second	Two short beeps	The Bluetooth® wireless link is ready for use.
Red for 0.5 second	Long beep	The Bluetooth® wireless link no longer exists.

Chapter 3 Reading Bar Codes

- Press the trigger switch to turn on the illumination LED and prepare the scanner for reading.
Note: This step is not required for the continuous reading and auto sensing modes (see Section 5.3).
- Align the scanner over the center of the target bar code so that the illumination longitudinally scans the center of the bar code.

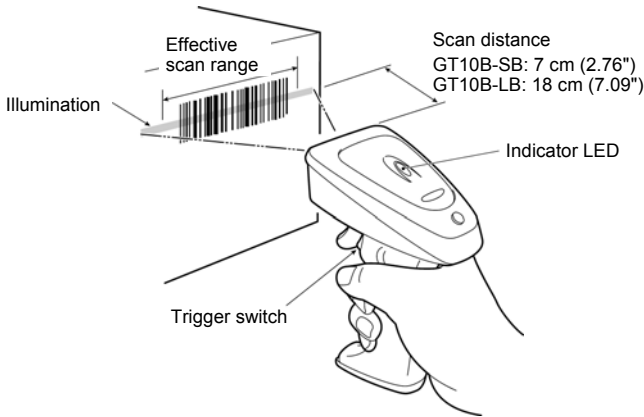

- Wait for the indicator LED to turn blue and the beeper to sound, indicating a successful read.

Note: While establishing a Bluetooth[®] wireless link, the scanner does not allow reading in things other than bar-coded parameter menu entries.

Note: The effective scan range is less than the full illumination range.

The effective scan range depends on the model and the distance from the scanner to the target.

GT10B-SB: approximately 10 cm (3.94") for a scan distance of 7 cm (2.76")

GT10B-LB: approximately 17 cm (6.69") for a scan distance of 18 cm (7.09")

Note: Having more than one bar code within the field of view either causes the read to fail or produces multiple input.

Note: Bar code orientation (right side up or upside down) does not matter as long as the margins are well within the field of view.

Note: It is sometimes necessary to vary the scanning angle or distance to eliminate reflections of the illumination and ambient light off highly reflective labels.

■ Scanning modes

Regular read mode	Successful completion of read-in produces data transfer.
Data verification mode	The scanner transfers only data that matches a predefined list of acceptable bar codes. (Refer to Chapter 7 for details.)

■ Speed-/depth-priority scanning

Speed-priority	The scanner gives priority to reducing the time spent decoding bar code data.
Depth-priority	The scanner gives priority to expanding the scan range.

For details, refer to Appendix 1.

■ Reading RSS-14 Stacked and RSS-14 Stacked Omnidirectional symbols

The scanner reads RSS-14 Stacked and RSS-14 Stacked Omnidirectional symbols in two steps. In the 1st step, it scans either one of the 1st and 2nd rows of the target symbol and accumulates the data in itself. In the 2nd step, it scans the remaining row, edits the 1st and 2nd row data read, and then sends the data to the host.

To inform the user that the 1st or 2nd row data has accumulated in the scanner, the scanner emits a one-shot beep by default. Upon completion of a successful read of the remaining row, the scanner emits a short beep just as upon completion of a read of any other type of bar code.

To discard the accumulated data halfway through a sequence of scanning, turn off the illumination LED. In the continuous reading mode or auto sensing mode, however, move the illumination away from the target symbol.

■ Switching to sleep mode for power saving

After completion of scanning, the scanner switches from standby to sleep mode to save power. The scanner in sleep mode takes more time to start and complete a sequence of scanning operation than the one on standby. Select the transition period from standby to sleep mode to meet your scanning intervals, using the configuration software (ScannerSetting).



Transition period from standby to sleep mode after completion of scanning:	Description
Immediately (default)	After completion of scanning, the scanner immediately switches to sleep mode. This setting is useful for operations with longer scanning intervals, e.g., 5 minutes or more.
5 seconds 15 seconds 30 seconds 1 minute 5 minutes	After completion of scanning, the scanner waits for the specified period and then switches to sleep mode. This setting is useful for intermittent scanning. Select a transition period suitable for your scanning intervals.
Disable	The scanner does not switch to sleep mode after completion of scanning. This setting is useful for operations with shorter scanning intervals, 5 seconds or less or when the scanning speed should have priority over the power saving.

Note: Selecting a longer transition period or disabling switching to sleep mode shortens the operation time of the battery cartridge.

■ Scanning with Bluetooth® wireless link broken

The scanner can read bar codes even with the Bluetooth® wireless link being broken. Use this scanning way when scanning bar codes is required but data transfer is not, for instance, when the scanner itself checks the verification result (with the scan lock enabled as described in Section 7.1) without transferring it to the host computer.

Scanning with Bluetooth® wireless link broken and that with Bluetooth® wireless link established can be switched only with the bar-coded parameter menu.

Scan w/ Bluetooth® link broken 	Allows the scanner to scan bar codes with the Bluetooth® wireless link being <u>broken</u> . This bar code also disables the Bluetooth® interface, making data transfer with the host computer impossible.
Cancel "Scan w/ Bluetooth® link broken" 	Cancels the "Scan w/ Bluetooth® link broken" setting. This bar code allows the scanner to scan bar codes with the Bluetooth® wireless link being <u>established</u> . It also enables the Bluetooth® interface, making data transfer with the host computer possible.

Note: The "Scan w/ Bluetooth® link broken" parameter retains its setting even the scanner reads the "End operation" and "Start operation" bar codes in this order with the "Scan w/ Bluetooth® link broken" being selected. To cancel the setting, you need to scan the "Cancel "Scan w/ Bluetooth® link broken"" bar code.

Chapter 4 Customizing the Scanner

You can customize the scanner by modifying communications, bar code type, and other scanner parameters with the bar-coded parameter menu or the configuration software ScannerSetting*. These parameters retain their settings even when the power is off.

TIP: The scanner can hold not only its own parameter settings but also Bluetooth® adapter parameter settings in its memory and customize the Bluetooth® adapter via the Bluetooth® wireless link. There are two types of bar-coded parameter menus available for scanners (Section 13.2) and Bluetooth® adapters (Section 14.2).

- (1) Scanning parameter setting bar codes from the **bar-coded parameter menu** by pressing the trigger switch.
(The bar-coded parameter menus for scanners and Bluetooth® adapters are given in Chapters 13 and 14, respectively.)
- (2) Using the **configuration software (ScannerSetting)*** in your computer. It is recommended that the scanner be configured as a master.
(This software also offers batch-process bar code printouts for read by scanners in the field.)

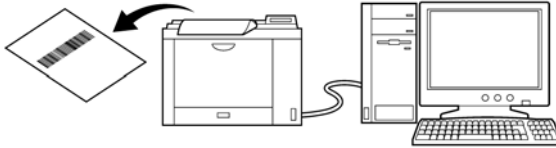

* Registered users can download the configuration software (ScannerSetting) from QBdirect, their customer support section on the Denso Wave website at no extra charge.

For further details on QBdirect or to register, visit the following URL.

<http://www.qbdirect.net>

Note: Customizing the scanner with the configuration software or batch-process bar code symbols breaks the Bluetooth® wireless link, so it is necessary to establish the link again after customizing.

Note: When the "End operation" is selected with the scanner, no parameter setting is possible. Prior to starting parameter setting, therefore, be sure to scan the "Start operation" bar code. See Chapter 2 for the "Start operation" and "End operation" bar codes.

Note: When even the scanner is being charged or discharged, you can customize it with the configuration software except when the "End operation" is selected. Note that customizing the scanner during discharge cancels discharging and starts charging instead.

Chapter 5 Scanning Control

Two types of scanning controls are available—Trigger switch control and Software control.

Trigger switch control: Pressing the trigger switch readies the scanner for scanning.

Software control: Instead of pressing the trigger switch, you send control commands from the host computer via the USB-COM interface to ready the scanner for scanning or put the scanner on standby.

5.1 Trigger Switch Control

Pressing the trigger switch turns on the illumination LED and readies the scanner for scanning. The scanner supports the following five trigger switch operating modes. Select the one that best meets your needs using the bar-coded parameter menu or the configuration software (ScannerSetting).

(1) Auto-off mode 1

Holding down the trigger switch lights the illumination LED for the specified period (selectable from 1 to 5 seconds in one second increments with the configuration software), during which the scanner is ready to scan.

When a bar code is read successfully or the specified period has elapsed, the illumination LED goes off and the scanner switches to standby.

(2) Auto-off mode 2

If you press the trigger switch, the illumination LED lights for approx. 5 seconds during which the scanner is ready to scan, regardless of whether a bar code is read successfully or the trigger switch is released.

After a bar code is read successfully, the ready-to-scan state further continues for approx. 5 seconds.

If the scanner is left without scanning operation for approx. 5 seconds, it turns off the illumination LED and switches to standby.

(3) Momentary switching mode 1 (Factory default)

Only while you hold down the trigger switch, the illumination LED lights and the scanner is ready to scan.

When you release the trigger switch or a bar code is read successfully, the illumination LED goes off and the scanner switches to standby.

(4) Momentary switching mode 2

Only while you hold down the trigger switch, the illumination LED lights and the scanner is ready to scan, regardless of whether a bar code is read successfully.

When you release the trigger switch, the illumination LED goes off and the scanner switches to standby.

(5) Continuous reading mode

When you turn the scanner on, the scanner lights the illumination LED and becomes ready to scan. The scanner ignores all trigger switch input.

Note: The scanner automatically enters the momentary switching mode 1 regardless of the current trigger switch operating mode when:

- the scanner is being customized with the bar-coded parameter menu
- the "End operation" is selected
- the Bluetooth® wireless link is broken

Note: The trigger switch is disabled as long as the scan lock (see Section 7.1.3) is in effect in the data verification mode.

5.2 Software Control

You can control the scanner by sending scanning control commands from the host computer, instead of pressing the trigger switch.

Scanning control commands include R, READON, LON, RC, Z, READOFF and LOFF and they are restricted by the trigger switch operating mode, as listed below. In momentary switching mode 1, for example, the RC command is invalid. In auto-off mode 2 and momentary switching mode 2, all of these commands are invalid.

(√: Command valid)

Commands	Description	Trigger switch operating modes				
		Auto-off mode 1	Auto-off mode 2	Momentary switching mode 1	Momentary switching mode 2	Continuous reading mode
R, READON, LON	<u>Ready-to-scan commands</u> Upon receipt of one of these commands, the scanner turns on the illumination LED and becomes ready to scan.	√	--	√	--	√
RC		--	--	--	--	√
Z, READOFF, LOFF	<u>Standby commands</u> Upon receipt of one of these commands, the scanner turns off the illumination LED and switches to standby.	--	--	√	--	√

Each of these commands should be enclosed with a header and terminator for transmission according to the communications conditions of the scanner.

Note: When the scanner is ready to scan with an R, READON or LON command, pressing the trigger switch cancels the command control, producing the operation specified for the trigger switch.

Notification of a scanning failure

If the scanner fails to read a bar code and switches to standby in auto-off mode 1 or momentary switching mode 1, it can send the following two types of notification data (cancel or error) to the host computer.

- CAN (18h)
- "ERROR" (with header and terminator)

Control scheme

(1) Auto-off mode 1 or momentary switching mode 1

Successful read

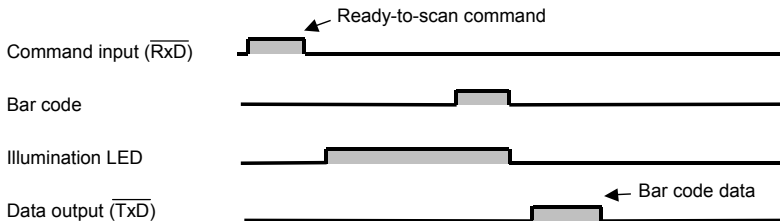

Failure read

- Auto-off mode 1

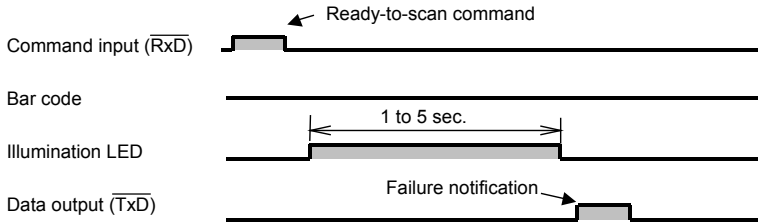

- Momentary switching mode 1

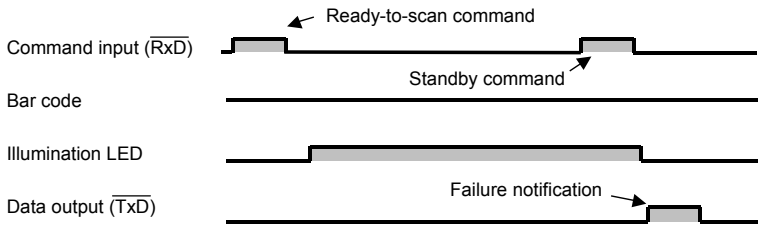

(2) Continuous reading mode

Switching to the ready-to-scan state with an R, READON or LON command

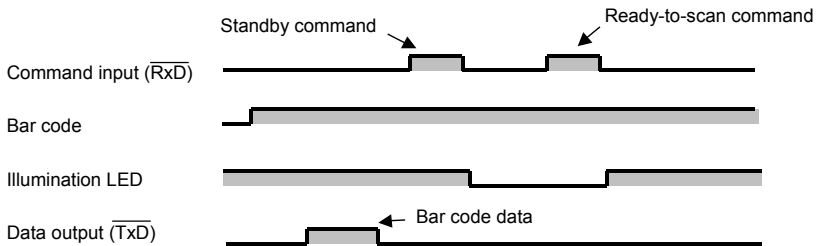

Switching to the ready-to-scan state with an RC command

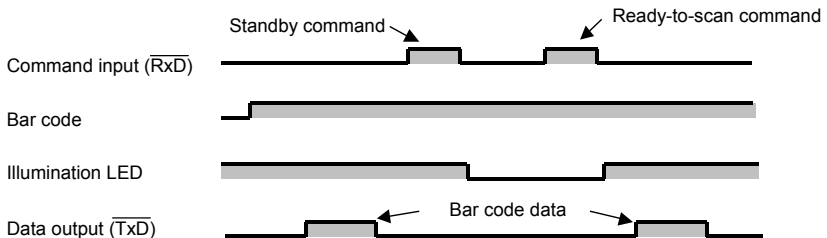

5.3 Auto Sensing Mode—Automatic Detection of Labels

In the auto sensing mode, bringing a code label within the scan range of the reading window turns on the illumination LED and starts the scanner reading the bar code. No trigger switch operation is required. Use this mode when the scanner is stationary to a stand and a bar code label is moved.

The illumination LED comes on when you bring a bar code label within the designated range or move a bar code label within the same range. The LED goes off when a bar code label is moved away from the range or stays within the range without move for approx. 5 seconds.

The scanner offers a choice of three sensitivity levels for responding to bar codes--High, Medium, and Low. Switch to a higher sensitivity level if the illumination LED will not come on when a bar code is brought into the range, for example.

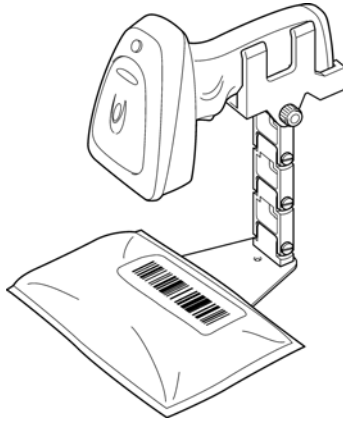

Note: Even if you do not bring a bar code label within the scan range, the illumination LED may come on when the ambient level of light changes or any shadows move within the scan range.

Note: Even if you do not bring a bar code label within the scan range, the illumination LED may come on when the ambient level of light changes or any shadows move within the scan range.

Note: Given below is a guide for scanning EAN-13 symbols in auto sensing mode under these conditions: At the center of the effective scan range and at the ambient illuminance of 500 lux or higher.

GT10B-SB: Scan distance of approx. 21 cm (8.27")

GT10B-LB: Scan distance of approx. 40 cm (15.75")

Note: It is sometimes necessary to vary the scanning angle or distance to eliminate reflections of the illumination and ambient light off highly reflective labels.

5.4 Reading with Scanner Mounted on Charger

A setting enables read operation with the scanner mounted on the charger, drawing its power from the charging pins, so reading can continue regardless of the battery cartridge's charge level.

The following table shows how the trigger switch operating mode affects charging while this function is in use. Momentary switch mode 1, for example, allows charging during standby intervals between reads. Configuring for continuous reading or auto sensing mode, however, disables recharging.

Scanner state		Trigger switch operating mode					
		Auto-off mode 1	Auto-off mode 2	Momentary switching mode 1	Momentary switching mode 2	Continuous reading mode	Auto sensing mode
<u>Charging during reads</u> - Reading in bar codes - Illumination LED ON		--	--	--	--	--	--
<u>Charging between reads</u>	Illumination LED OFF after completion of bar code reading	√	√	√	√	--	--
	On standby after receipt of Z, READOFF, or LOFF command	√	√	√	√	√	--

Note: Scanners with the following model numbers have this enable setting, but do not support reading.

- 454800-8620
- 454800-8630

Chapter 6 Magic Key Control

Holding down the magic key breaks Bluetooth® wireless links. Note that, in the data verification mode, it cannot break those links since the magic key is used to register master data.

The magic key can also act as an auxiliary key for scanning or data transfer. You can assign any of the following five functions or no function at all to the magic key. Select the function that best meets your needs using the bar-coded parameter menu or the configuration software (ScannerSetting).

(1) Illumination switching function

Pressing the magic key turns the illumination LED on and off in alternation.

Note that even if the illumination LED is lit by pressing the magic key, the scanner does not become ready to scan. To make the scanner ready, press the trigger switch.

If the illumination LED has been lit for approx. 3 seconds without completion of a scanning operation, it will automatically go off.

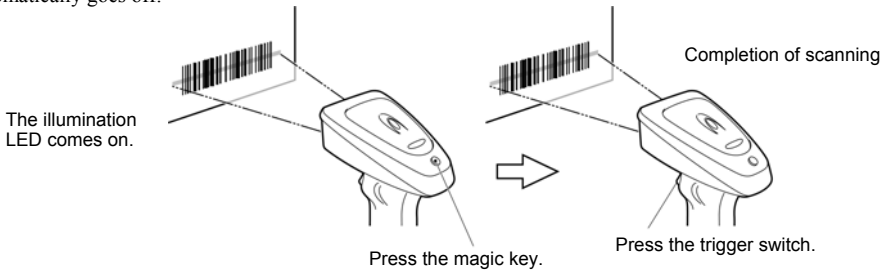

(2) Data retransfer function

Pressing the magic key retransfers the last data sent. Note, however, that the scanner ignores this command if there is no such data available--that is, in any of the following cases that follow bar code reading.

- When the scanner has read the "Start operation" or "End operation" bar code
- When you have customized the scanner by modifying the parameters with the configuration software (ScannerSetting), bar-coded parameter menu, or batch-process bar code symbols
- When the scanner power has been turned off due to the removal/replacement of the battery cartridge or the low battery.

(3) Specific character transfer function

Pressing the magic key transfers a character string (max. 10 bytes) specified with the configuration software (ScannerSetting).

(4) Ready/standby switching function

When the trigger switch is in the continuous reading mode, pressing the magic key switches the scanner between ready-to-scan (illumination LED ON) and standby (illumination LED OFF).

(5) Auto sensing mode switching function

Pressing the magic key toggles between the auto sensing mode and the currently selected trigger switch operating mode.

(6) Continuous reading mode switching function

Pressing the magic key toggles between the continuous reading mode and the currently selected trigger switch operating mode.

(7) No function (Disable)

If no function has been assigned to the magic key, pressing the key produces no operation.

The following table lists the relationship between the magic key functions and trigger switch operating modes. (It applies to both the regular read mode and data verification mode.) The "--" indicates that the scanner ignores the magic key functions assigned. In auto-off mode 1, for example, the ready/standby switching function is ignored.

Magic key functions	Trigger switch operating modes					Auto sensing mode
	Auto-off mode 1	Auto-off mode 2	Momentary switching mode 1	Momentary switching mode 2	Continuous reading mode	
Illumination switching function	√	√	√	√	--	--
Data retransfer function	√	√	√	√	√	√
Specific character transfer function	√	√	√	√	√	√
Ready/standby switching function	--	--	--	--	√	--
Auto sensing mode switching function	√	√	√	√	√	--
Continuous reading mode switching function	√	√	√	√	--	√
No function	√	√	√	√	√	√

Note: In any of the following cases, the magic key is disabled regardless of the current function being assigned.

- When the "End operation" is selected
- When the Bluetooth® wireless link is broken, except when the "Scan w/ Bluetooth® wireless link broken" is selected

Note: Selecting the "Scan w/ Bluetooth® wireless link broken" disables the following magic key functions.

- Data retransfer function
- Specific character transfer function

Chapter 7 Scanning Functions

7.1 Data Verification Mode

The data verification mode verifies the bar code data read against the master data stored in the scanner and reports the match status with data output.

Data verification read is available in two types--"n-point verification" and "2-point verification."

Selecting the n-point verification requires registering master data only one time for 1:n verification. The scanner verifies all bar code data read after registration against the master data.

The 2-point verification refers to 1:1 verification. Selecting it requires registering master data each time preceding bar code scanning. After registration of master data, the scanner reads a bar code, verifies the bar code data read against the master data and then becomes ready to register new master data. This way, the 2-point verification read alternately repeats master data registration and bar code scanning.

The master data registration procedure is different in n-point and 2-point verification reads. (See Section 7.1.1.)

The verification parameters can be specified using the bar-coded parameter menu or configuration software (ScannerSetting). After specifying them, scan a master bar code, and the scanner becomes capable of data verification read.

7.1.1 Verification setup procedure

■ n-point verification read

After one-time registration of master data, the scanner verifies all bar code data read after registration against the master data.

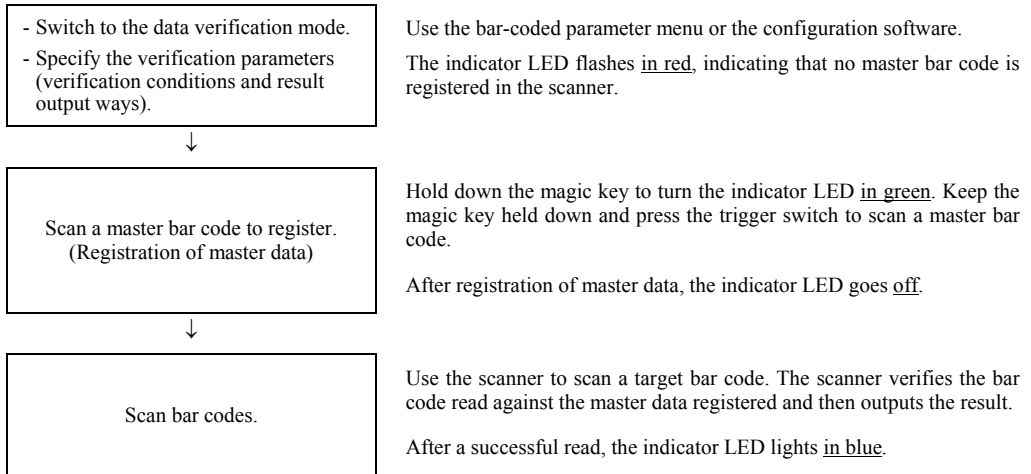

Note: For what clears the registered master data, see the next page.

■ 2-point verification read

After registration of master data, the scanner reads a bar code, verifies the bar code data read against the master data and then becomes ready to register *new* master data.

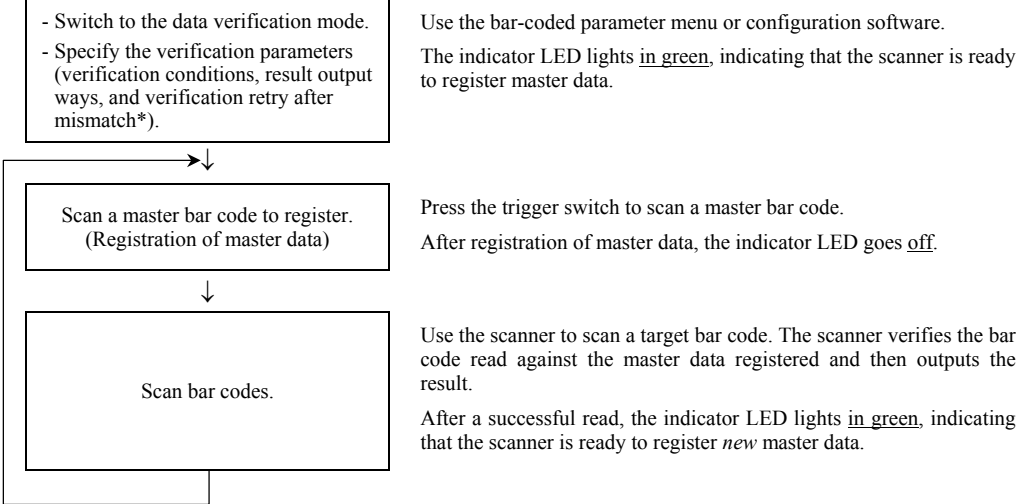

*Verification retry after mismatch in 2-point verification

The 2-point verification read provides the "Verification retry after mismatch" option that retries verification against the *same* master data. Enabling this option readies the scanner not for registering *new* master data but for reading a bar code again if the verification result is a mismatch.

Disabling this option readies the scanner for registering *new* master data after bar code reading, no matter what the verification result is.

Note: Any of the following events clears the master data stored in the scanner.

- Scanning the "Start operation" or "End operation" bar code with the scanner.
- Customizing the scanner by modifying the parameters with the configuration software (ScannerSetting) or batch-process bar code symbols.
- Modifying the "verification start position in data verification mode" or "number of characters to verify, starting from the verification start position" setting with the bar-coded parameter menu.
- The scanner power is turned off due to the removal/replacement of the battery cartridge or the low battery.

Note: In the data verification mode, the magic key is used to register master data, not used to break the Bluetooth® wireless link. To break the link, scan the "Break Bluetooth® wireless link" bar code. Note that when the scanner, as a master, is searching for a connection target or it is, as a slave, waiting for a master to connect, the magic key can break the Bluetooth® wireless link. See Section 2.3 for details about the "Break Bluetooth® wireless link" bar code.

Note: To break the Bluetooth® wireless link with no master data registered, follow the procedure set forth in Section 7.1.5.

Note: Registering master data is not possible without a Bluetooth® wireless link.





Note: Enabling "Reading with scanner mounted on charger" allows registering of master data on the charger, but the indicator LED gives priority to displaying the charge state.

7.1.2 Verification conditions

You can specify a verification starting position and the number of characters to check.

- Starting position: The choices are 1st through 7th characters.
- Number of characters: The choices are 1 through 7 and everything following the starting position (up to a maximum of 32 characters).

For example, you can specify all characters or particular characters of bar code data to check as shown below.

<p>Master data</p>  <p><u>12345601</u></p> <p>Bar code data readable</p>  <p><u>12345601</u></p>	<p>Verification conditions: All characters to check</p> <p>To check all characters as underlined at left, for example, set the following:</p> <ul style="list-style-type: none">- Starting position: 1st character- Number of characters: All characters <p>Max. 32 bytes of bar code data can be verified.</p>
<p>Master data</p>  <p><u>12345601</u></p> <p>Bar code data readable</p>  <p>01<u>347803</u></p>	<p>Verification conditions: Particular characters to check</p> <p>To check particular characters as underlined at left, for example, set the following:</p> <ul style="list-style-type: none">- Starting position: 3rd character- Number of characters: 2 characters

Note: If the bar code type (symbology) of data read is different from that of the master data, the verification results in a mismatch even if those data matches.

7.1.3 Verification result output

(1) Report of match/mismatch status

You can select any of the following report types by using the bar-coded parameter menu or configuration software (ScannerSetting). Selecting "Disable transmission" reports nothing.

Setting	If there is a match:	If there is a mismatch:
1	Disable transmission.	Disable transmission.
2	Enable bar code data transmission.	Disable transmission.
3	Enable bar code data transmission.	Enable NG transmission.
4	Enable OK transmission.	Enable NG transmission.

(2) Beeper, indicator LED and vibrator

You can check whether the verification result is a match or mismatch, with the beeper, indicator LED and vibrator. When the beeper, indicator LED and vibrator are enabled, they act as listed below.

	Beeper	Indicator LED	Vibrator	
			"OK" vibrations	"NG" vibrations
If there is a match:	Emits a short beep.	Lights in blue.	Operates.	--
If there is a mismatch:	Emits a long beep.	Lights in red.	--	Operates.

(3) Scan lock

The scan lock function locks the scanner on standby if the verification result is a mismatch. You can enable or disable this function with the bar-coded parameter menu or configuration software (ScannerSetting).

Once the scanner is locked, it switches to standby regardless of the current trigger switch control selected. The scanner remains on standby even if the trigger switch is pressed or a ready-to-scan command (R, READON or LON) is received.

Pressing the magic key or reloading the battery cartridge releases the scan lock.

Note: In the data verification mode, the magic key is used to register a master bar code, not used to break the Bluetooth® wireless link. To break the link, scan the "Break Bluetooth® wireless link" bar code. Note that when the scanner, as a master, is searching for a connection target or it is, as a slave, waiting for a master to connect, the magic key can break the Bluetooth® wireless link. See Section 2.3 for the "Break Bluetooth® wireless link" bar code.

Note: Removing the battery cartridge clears master data stored in the scanner.

Note: In any of the following cases, the scan lock is disabled regardless of the current setting.

- When the "End operation" is selected
- When the Bluetooth® wireless link is broken, except when the "Scan w/ Bluetooth® wireless link broken" is selected

Note: Breaking and connecting the Bluetooth® wireless link does not release the scan lock. Clearing the master data stored releases the scan lock.

7.1.4 Output of the master data registered

Scanning the "Output master data" bar code given below lets the scanner output the master data registered in the verification setup procedure.

Note: In the 2-point verification read, the scanner cannot read this bar code, so it cannot output master data.



Output master data

7.1.5 Breaking the Bluetooth® wireless link with no master data registered

To break the Bluetooth® wireless link with no master data registered, follow the procedure given below.

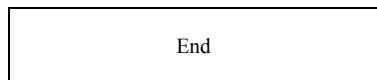
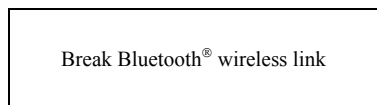

Hold down the magic key to turn the indicator LED green. With the magic key held down, press the trigger switch to scan the "Break Bluetooth® wireless link" bar code (given in Section 2.3).

Wait for the scanner to beep three times and the indicator LED to turn blue, indicating a successful disconnection.



7.2 Specifying the Numbers of Digits of Standard 2of5 and Interleaved 2of5 Symbols to Read, by Scanning Bar Codes

You can specify the numbers of digits of Standard 2of5 and Interleaved 2of5 symbols to read.

First enable the parameter "specification of the number of digits by bar code scanning" by using the bar-coded parameter menu or configuration software. Then scan Standard 2of5 or Interleaved 2of5 symbols. The numbers of digits of symbols scanned first and second (after you enable the parameter or turn the scanner on) will be registered in the memory.

After the registration, the scanner can read only Standard 2of5 or Interleaved 2of5 symbols having either of those specified numbers of digits.

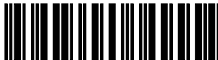
(Example)

 <p>123457</p>  <p>1234567895</p>	<p><u>Specifying the number of digits readable</u></p> <p>First scan: 6-digit Interleaved 2of5 symbol</p> <p>→ Just the bar code type and the number of digits will be stored in the scanner. The code data will be sent.</p> <p>Second scan: 10-digit Interleaved 2of5 symbol</p> <p>→ Just the bar code type and the number of digits will be stored in the scanner. The code data will be sent.</p> <p>After that, 6-digit and 10-digit Interleaved 2of5 symbols only can be read.</p>
 <p>987653</p>  <p>98765430</p>	<p><u>Scanning after setting the number of digits readable</u></p> <p>6-digit Interleaved 2of5 bar code</p> <p>→ This bar code can be read.</p> <p>8-digit Interleaved 2of5 bar code</p> <p>→ This bar code cannot be read.</p>

Note: Any of the following events clears the number of digits specified above.

- Scanning the "Start operation" or "End operation" bar code with the scanner.
- Customizing the scanner by modifying the parameters with the configuration software (ScannerSetting), bar-coded parameter menu, or batch-process bar code symbols.
- The scanner power is turned off due to the removal/replacement of the battery cartridge or the low battery.

Chapter 8 Data Editing

The scanner can edit bar code data read in the format specified with the configuration software (ScannerSetting) and transfer it to the host computer.

The format specification parameters retain their settings until the configuration software (ScannerSetting) or bar-coded parameter menu sets "All defaults."

8.1 Extracting Data

The scanner extracts a part of bar code data read according to the extraction conditions--"Specified number of digits from head position," "Specified number of digits from tail position," "From the specified start to tail positions," and "From the specified start to end positions."

The following sample bar code and scanner settings output data as listed below depending upon the extraction conditions.

- Bar code sample

Bar code type: Code 128, Data read: 1234567890

- Scanner settings

Header: STX, Terminator: ETX, Prefix/Suffix: None, Code ID mark: Type 1,
Transmission of number of digits: 2 digits

(1) Extracting the specified number of digits of data from head position

The number of digits must be within the range from 1 to 99. If the number of digits in bar code data read is less than the one specified, an error occurs.

(Example)

Number of digits	Output data
3 digits	[STX]K03123[ETX]
8 digits	[STX]K0812345678[ETX]
12 digits	Error

(2) Extracting the specified number of digits of data from tail position

The number of digits must be within the range from 1 to 99. For example, three digits of data from the tail position contain "890." If the number of digits in bar code data read is less than the one specified, an error occurs.

(Example)

Number of digits	Output data
3 digits	[STX]K03890[ETX]
8 digits	[STX]K0834567890[ETX]
12 digits	Error

(3) Extracting data from the specified start to tail positions

The start position must be within the range from the 2nd to 99th digits. If the number of digits in bar code data read does not reach the specified start position, an error occurs.

(Example)

Start position	Output data
3rd digit	[STX]K0834567890[ETX]
8th digit	[STX]K03890[ETX]
12th digit	Error

(4) Extracting data from the specified start to end positions

The start and end positions must be within the range from 2nd to 99th digits each. The end position must be equal to or greater than the start position. If the number of digits in bar code data read does not reach the specified start or end position, an error occurs.

(Example)

Start position	End position	Output data
3rd digit	7th digit	[STX]K0534567[ETX]
8th digit	10th digit	[STX]K03890[ETX]
10th digit	11th digit	Error

8.2 Substituting Data

The scanner searches for the specified string (max. 10 characters long) in bar code data read, starting from the specified start position (the head to the 10th position) to the end. If the bar code data contains the specified string, the scanner substitutes it with the specified substitution string (max. 3 characters long) and transfers it according to the substitution conditions--"Transferring the substituted element string only," "Transferring the substituted element string + bar code data," and "Transferring the substituted full string."

The following sample bar code and scanner settings output data as listed below depending upon the substitution conditions.

- Bar code sample

Bar code type: Code 128, Data read: 1234567890

- Scanner settings

Header: STX, Terminator: ETX, Prefix/Suffix: None, Code ID mark: Type 1,
Transmission of number of digits: 2 digits

(1) Transferring the substituted element string only

If the bar code data contains the specified substitution string within the specified search area, the scanner transfers the substituted element string only.

(Example)

Search start position	Search string	Substitution string	Output data
2nd digit	456	A	[STX]K01A[ETX]
5th digit	890	XYZ	[STX]K03XYZ[ETX]
9th digit	890	XYZ	Error

(2) Transferring the substituted element string

If the bar code data contains the specified substitution string within the specified search area, the scanner transfers the substituted element string followed by the bar code data read.

(Example)

Search start position	Search string	Substitution string	Output data
2nd digit	456	A	[STX]K11A1234567890[ETX]
5th digit	890	XYZ	[STX]K13XYZ1234567890[ETX]
9th digit	890	XYZ	Error

(3) Transferring the substituted full string

If the bar code data contains the specified substitution string within the specified search area, the scanner substitutes the search string with the substitution string and transfers the full string. If it contains two or more search strings, only the first one is substituted.

(Example)

Search start position	Search string	Substitution string	Output data
2nd digit	456	A	[STX]K08123A7890[ETX]
5th digit	890	XYZ	[STX]K101234567XYZ[ETX]
9th digit	890	XYZ	Error

8.3 Blocksoring Data

The scanner splits bar code data read into a maximum of 5 blocks at the specified split positions and sorts those blocks in the specified order.

The split position must be specified by the number of digits from the head of bar code data. Specifying the number of digits exceeding that in the bar code data results in an error.

The following sample bar code and scanner settings output data as listed below depending upon the sorting conditions.

- Bar code sample

Bar code type: Code 128, Data read: 1234567890

- Scanner settings

Header: STX, Terminator: ETX, Prefix/Suffix: None, Code ID mark: Type 1,
Transmission of number of digits: 2 digits

(Example)

Split position	Order of blocks	Output data
3rd and 8th digits	Block 2, 1, 3	[STX]K104567812390[ETX]
3rd and 8th digits	Block 1, 3	[STX]K0512390[ETX]

8.4 Parenthesizing AIs (Application Identifier) in EAN-128 Data

The scanner parenthesizes all AIs contained in EAN-128 data read and transfers the data. (For the definition of AIs, see Section 8.6.3.)

The following sample bar code and scanner settings output data with AIs parenthesized as listed below.

- Bar code sample

Bar code type: EAN-128, Data read: 0194901234567894(11)030808(13)030810(17)040208

- Scanner settings

Header: STX, Terminator: ETX, Prefix/Suffix: None, Code ID mark: Type 1,
Transmission of number of digits: 2 digits

(Example)

Output data
[STX]W48(01)94901234567894(11)030808(13)030810(17)040208[ETX]

8.5 Extracting AI (Application Identifier)-Prefixed Strings from EAN-128 Data

The scanner extracts element strings prefixed with the specified AIs (up to three types of AIs) and separates them with the specified delimiters (selectable from headers/terminators, commas, and tabs) instead of AIs to transfer them. (For the definition of AIs, see Section 8.6.3.)

The following sample bar code and scanner settings output data as listed below depending upon the AI conditions.

- Bar code sample

Bar code type: EAN-128, Data read: (01)94901234567894(11)030808(13)030810(17)040208

- Scanner settings

Header: STX, Terminator: ETX, Prefix/Suffix: None, Code ID mark: Type 1,
Transmission of number of digits: 2 digits

(1) Header/terminator

Specifying a header/terminator as a delimiter prefixes a header and suffixes a terminator to each element string separated.

A prefix, suffix, the number of digits, and code ID mark can be also added to each element string if their transmissions are enabled. The number of digits is the count in each element string edited.

(Example)

AIs specified	Output data
AI1=01, AI2=17	[STX]W1494901234567894[ETX] [STX]W06040208[ETX]

(2) Comma

Specifying a comma as a delimiter outputs comma-delimited data. No comma follows the tail of the data.

A header and terminator are added to the full string. A prefix, suffix, the number of digits, and code ID mark can be also added to the full string if their transmissions are enabled. The number of digits is the count in the full string edited.

(Example)

AIs specified	Output data
AI1=01, AI2=17	[STX]W2194901234567894,040208[ETX]

(3) Tab (ASCII 09h <HT>)

Specifying a tab as a delimiter outputs tab-delimited data. No tab follows the tail of the data.

A header and terminator are added to the full string. A prefix, suffix, the number of digits, and code ID mark can be also added to the full string if their transmissions are enabled.

Scanners equipped with PS/2 keyboard interfaces also transfer ASCII 09h for tab, instead of TAB key.

(Example)

AIs specified	Output data
AI1=01, AI2=17	[STX]W2194901234567894[HT]040208[ETX]

8.6 Data Editing Notes

8.6.1 Data edit conditions

For data editing, the following conditions can be specified.

(1) Code type

All bar code types or an arbitrary bar code type can be specified. This applies to "data extraction," "data substitution," and "blocksorting."

(2) Code length

None or the maximum number of digits (1 to 99 digits) can be specified.

(3) Enable/disable transmission at the occurrence of an error

The transmission of data that does not match the data editing conditions can be enabled or disabled.

8.6.2 Rules for data editing

Note the following important rules for editing data with this scanner. They apply to "data extraction," "data substitution," and "blocksorting."

(1) Data editing applies to bar code data.

(2) A search string should consist of ASCII characters (00h to 7Fh) and a substitution string, ASCII characters (00h to FEh).

(3) There can be at most one data editing condition.

(4) Enabling the prefix, suffix, number of digits, and code ID mark settings adds them to the output. Note, however, that the number of digits is that after editing.

(5) The number of digits includes any check digit--except for Code 93, Code 128, and EAN-128 symbologies.

(6) Disabling check digits still produces them in the output if they are present after editing.

(7) Conversions from the UPC-A format always include the leading character for adjusting the number of transfer digits and the number system character.

(8) Conversions from the UPC-E format always skip the leading character for adjusting the number of transfer digits and the number system character. Conversions to the UPC-E format do as well.

(9) Conversions from the EAN-13 format always include the country code. ISBN/ISSN conversions ignore it.

(10) Conversions from EAN-8 to EAN-13 format are ignored.

(11) Conversions from UPC-A, UPC-E, EAN-13, EAN-8, or Interleaved 2of5 (14-digit) to GTIN format are ignored.

- (12) Conversions apply to Codabar start/stop characters and include them in the number of digits.
- (13) Conversions force Codabar start/stop characters, if included in the output, to lower case.
- (14) Conversions skip Code 39 start/stop characters and do not include them in the number of digits.
- (15) The output never contains Code 39 start/stop characters regardless of their settings.
- (16) Code 39 full ASCII conversion, if enabled, applies before data editing.
- (17) Conversions skip FNC characters in Code 128 and EAN-128 in both the number of digits and the input. The only exception is with GS conversion of FNC1 characters.

8.6.3 AI table

In "Parenthesizing AIs (Application Identifier) in EAN-128 data" (Section 8.4) and "Extracting AI (Application Identifier)-prefixed strings from EAN-128 data" (Section 8.5), the scanner edits data according to the definition of the table below.

The format in the AI table is coded as listed below.

a	Alphabetic character
a3	Three digits alphabetic characters
a..3	Up to three digits alphabetic characters
n	Numerical character
n3	Three digits numerical characters
n..3	Up to three digits numerical characters
an	Alphanumeric character
an3	Three digits alphanumeric characters
an..3	Up to three digits alphanumeric characters

AI table

AI	Format	Description
00	n2+n18	Serial Shipping Container Code (SSCC)
01	n2+n14	Global Trade Item Number (GTIN)
02	n2+n14	GTIN of Trade Items Contained in a logistic unit (For Use with AI 37 Only)
03	n2+n14	Reserved Area
04	n2+n16	Reserved Area
10	n2+an..20	Batch or Lot Number
11	n2+n6	Production Date (YYMMDD) (*)
12	n2+n6	Due Date (YYMMDD) (*)
13	n2+n6	Packaging Date (YYMMDD) (*)
15	n2+n6	Best Before Date (YYMMDD) (*)
17	n2+n6	Expiration Date (YYMMDD) (*)
20	n2+n2	Product Variant
21	n2+an..20	Serial Number
22	n2+an..29	HIBCC (Health Industry Business Communication Council)--Quantity, Date, Batch, and Link

AI	Format	Description
23n	n3+n..19	Batch or Lot Number (Transitional Use) (**)
240	n3+an..30	Additional Product Identification Assigned by the Manufacturer
241	n3+an..30	Customer Part Number
250	n3+an..30	Secondary Serial Number
251	n3+an...30	Reference to Source Entity
252	n3+n27	Global Serial Number
253	n3+n13+n..17	Global Document Type Identifier
30	n2+n..8	Quantity
310n	n4+n6	Net Weight, Kilograms (***)
311n	n4+n6	Length or 1st Dimension, Meters (***)
312n	n4+n6	Width, Diameter, or 2nd Dimension, Meters (***)
313n	n4+n6	Depth, Thickness, Height, or 3rd Dimension, Meters (***)
314n	n4+n6	Area, Square Meters (***)
315n	n4+n6	Volume, Liters (***)
316n	n4+n6	Volume, Cubic Meters (***)
320n	n4+n6	Net Weight, Pounds (***)
321n	n4+n6	Length or 1st Dimension, Inches (***)
322n	n4+n6	Length or 1st Dimension, Feet (***)
323n	n4+n6	Length or 1st Dimension, Yards (***)
324n	n4+n6	Width, Diameter, or 2nd Dimension, Inches (***)
325n	n4+n6	Width, Diameter, or 2nd Dimension, Feet (***)
326n	n4+n6	Width, Diameter, or 2nd Dimension, Yards (***)
327n	n4+n6	Depth, Thickness, Height, or 3rd Dimension, Inches (***)
328n	n4+n6	Depth, Thickness, Height, or 3rd Dimension, Feet (***)
329n	n4+n6	Depth, Thickness, Height, or 3rd Dimension, Yards (***)
330n	n4+n6	Gross Weight, Kilograms (***)
331n	n4+n6	Length or 1st Dimension, Meters, Logistics (***)
332n	n4+n6	Width, Diameter, or 2nd Dimension, Meters, Logistics (***)
333n	n4+n6	Depth, Thickness, Height, or 3rd Dimension, Meters, Logistics (***)
334n	n4+n6	Area, Square Meters, Symbology (***)
335n	n4+n6	Gross Volume, Liters (***)
336n	n4+n6	Gross Volume, Cubic Meters (***)
337n	n4+n6	Kilograms per Square Meter (pressure) (***)
340n	n4+n6	Gross Weight, Pounds (***)
341n	n4+n6	Length or 1st Dimension, Inches, Logistics (***)
342n	n4+n6	Length or 1st Dimension, Feet, Logistics (***)
343n	n4+n6	Length or 1st Dimension, Yards, Logistics (***)
344n	n4+n6	Width, Diameter, or 2nd Dimension, Inches, Logistics (***)

AI	Format	Description
345n	n4+n6	Width, Diameter, or 2nd Dimension, Feet, Logistics (***)
346n	n4+n6	Width, Diameter, or 2nd Dimension, Yards, Logistics (***)
347n	n4+n6	Depth, Thickness, Height, or 3rd Dimension, Inches, Logistics (***)
348n	n4+n6	Depth, Thickness, Height, or 3rd Dimension, Feet, Logistics (***)
349n	n4+n6	Depth, Thickness, Height, or 3rd Dimension, Yards, Logistics (***)
350n	n4+n6	Area, Square Inches (***)
351n	n4+n6	Area, Square Feet (***)
352n	n4+n6	Area, Square Yards (***)
353n	n4+n6	Area, Square Inches, Logistics (***)
354n	n4+n6	Area, Square Feet, Logistics (***)
355n	n4+n6	Area, Square Yards, Logistics (***)
356n	n4+n6	Net Weight, Troy Ounces (***)
357n	n4+n6	Net Volume, Ounces (***)
360n	n4+n6	Volume, Quarts (***)
361n	n4+n6	Volume, Gallons (***)
362n	n4+n6	Gross Volume, Quarts (***)
363n	n4+n6	Gross Volume, Gallons (***)
364n	n4+n6	Volume, Cubic Inches (***)
365n	n4+n6	Volume, Cubic Feet (***)
366n	n4+n6	Volume, Cubic Yards (***)
367n	n4+n6	Gross Volume, Cubic Inches (***)
368n	n4+n6	Gross Volume, Cubic Feet (***)
369n	n4+n6	Gross Volume, Cubic Yards (***)
37	n2+n..8	Quantity (For Use with AI 02 Only)
390n	n4+n..15	Amount Payable--Single Monetary Area (****)
391n	n4+n3+n..15	Amount Payable and ISO Currency Code (****)
392n	n4+n..15	Amount Payable for a Variable Measure Trade Item--Single Monetary Area (****)
393n	n4+n3+n..15	Amount Payable for a Variable Measure Trade Item and ISO Currency Code (****)
400	n3+an..30	Customer's Purchase Order Number
401	n3+an..30	Consignment Number
402	n3+n17	Shipment Identification Number
403	n3+an..30	Routing Code
410	n3+n13	Ship to (Deliver to) EAN.UCC Global Location Number
411	n3+n13	Bill to (Invoice to) EAN.UCC Global Location Number
412	n3+n13	Purchased from EAN.UCC Global Location Number
413	n3+n13	Ship for (Deliver for) EAN.UCC Global Location Number

AI	Format	Description
414	n3+n13	Identification of a Physical Location--EAN.UCC Global Location Number
415	n3+n13	EAN.UCC Global Location Number of the Invoicing Party
420	n3+an..20	Ship to (Deliver to) Postal Code Within a Single Postal Authority
421	n3+n3+n..9	Ship to (Deliver to) Postal Code with Three-Digit ISO Country Code Prefix
422	n3+n3	Country of Origin of a Trade Item
423	n3+n3+n..12	Country of Initial Processing
424	n3+n3	Country of Processing
425	n3+n3	Country of Disassembly
426	n3+n3	Country of Final Processing
43	n2+n4+n7+an6..10+n1	Carrier Assigned Tracking Number
7001	n4+n13	NATO Stock Number (NSN)
7002	n4+an..30	UN/ECE Meat Carcasses and Cuts Classification
7030	n4+n3+an..27	Approval Number of Processor with Three-Digit ISO Country Code, Butchery
7031	n4+n3+an..27	Approval Number of Processor with Three-Digit ISO Country Code, 1st Processing Place
703n	n4+n3+an..27	Approval Number of Processor with Three-Digit ISO Country Code, 2nd to 9th Processing Places
8001	n4+n14	Roll Products--Width, Length, Core Diameter, Direction, and Splices
8002	n4+an..20	Cellular Mobile Telephone Identifier
8003	n4+n14+an..16	EAN.UCC Global Returnable Asset Identifier (GRAI)
8004	n4+an..30	EAN.UCC Global Individual Asset Identifier (GIAI)
8005	n4+n6	Price Per Unit of Measure
8006	n4+n14+n2+n2	Identification of the Component of a Trade Item
8007	n4+an..30	International Bank Account Number (IBAN)
8008	n4+n8+n..4	Date and Time of Production (YYMMDDHHMMSS)
8018	n4+n18	EAN.UCC Global Service Relation Number (GSRN)
8020	n4+an..25	Payment Slip Reference Number
8100	n4+n1+n5	UPC Coupon Extended Code--Number System Character and Offer Code
8101	n4+n1+n5+n4	UPC Coupon Extended Code--Number System Character, Offer Code, and End of Offer Code
8102	n4+n1+n1	UPC Coupon Extended Code--Number System Character Preceded by Zero
90	N2+an..30	FACT Data Identifiers
91	N2+an..30	Company Internal Information--Company
92	N2+an..30	Company Internal Information--Company
93	n2+an..30	Company Internal Information--Company

AI	Format	Description
94	n2+an..30	Company Internal Information--Company
95	n2+an..30	Company Internal Information--Carrier
96	n2+an..30	Company Internal Information--Carrier
97	n2+an..30	Company Internal Information--Company
98	n2+an..30	Company Internal Information--Company
99	n2+an..30	Company Internal Information

(*) To indicate only year and month, DD must be FILLED with "00."

(**) n indicates the length of data.

(***) n indicates the decimal point position.

(****) n indicates the number of digits after decimal point

Note 1: The EAN-128 AIs are compliant with the General EAN.UCC Specifications v. 6.0.

Note 2: If the specified AI is variable in length and the number of digits in data read is less than the maximum number of digits defined for the AI, the output contains a GS (1Dh) in the data read.

Chapter 9 Beeper, Indicator LED and Vibrator

9.1 Beeper

(1) Beeping

The scanner emits a short, long, one-shot, or intermittent beep to indicate the scanner status as described below. The intermittent and one-shot beeps apply when the scanner reads an RSS-14 Stacked or RSS-14 Stacked Omnidirectional symbol.

The beeper can be disabled with the bar-coded parameter menu or configuration software (ScannerSetting); however, in some cases it sounds regardless of the beeper setting. For details, see the next page.

Note: Whether to enable or disable the beeper when the scanner reads RSS-14 Stacked or RSS-14 Stacked Omnidirectional symbols can be selected with the "Beeper when reading RSS-14 Stacked/RSS-14 Stacked Omnidirectional" bar code on the bar-coded parameter menu. The "Beeper" bar code for other bar codes has no effect on RSS-14 Stacked or RSS-14 Stacked Omnidirectional symbols.

A short beep (60, 80, or 120 ms selectable*) when:

- a read of a bar code is successfully complete,
 - master data registration is successfully complete in the verification setup procedure,
 - bar code data read matches the master data in the data verification mode,
 - data retransfer or specific character transfer with the magic key is complete,
 - bar code data read in the specified data editing matches the editing conditions,
 - the scanner has read a parameter setting bar code from the bar-coded parameter menus (given in Chapters 13 and 14), or
 - the scanner has read the "DATA" bar code out of batch-process bar code symbols generated with the configuration software.
-

A short beep of 60 ms when:

- the "Start setting" or "End setting" bar code is read from the bar-coded parameter menus (given in Chapters 13 and 14),
 - the scanner configuration is switched from master to slave, or vice versa,
 - the scanner has read the "START" or "END" bar code out of batch-process bar code symbols generated with the configuration software,
 - the configuration software starts up or accepts new setting,
 - a Bluetooth® wireless link is established with the Bluetooth® adapter,
 - the charge of the battery cartridge has lowered, turning the scanner off, or
 - the setting cannot be made because the "START" barcode from a batch-process barcode printed with a version of the configuration software that does not match the scanner firmware was scanned.
-

A long beep of 180 ms when:

- parameter setting with the bar-coded parameter menus (given in Chapters 13 and 14) has failed.
-

A long beep of 480 ms when:

- a master bar code has the wrong number of digits during registration of master data,
 - bar code data read does not match the master data in the data verification mode,
 - bar code data read in the specified data editing does not match the editing conditions, resulting in no transfer,
 - a transmission error or timeout has occurred during communication with the configuration software (ScannerSetting),
 - a communications error has occurred,
 - the previously sent data is not available at the time of data retransfer (using the magic key),
 - three minutes have elapsed without scanning any parameter setting bar code from the bar-coded parameter menus (given in Chapters 13 and 14) in the parameter setting procedure,
 - a Bluetooth® wireless link is established with a Bluetooth® device other than the Bluetooth® adapter,
 - a Bluetooth® wireless link is established between the scanner using data packaging (packetizing) and any Bluetooth® device not supporting data packaging,
 - transfer of parameter settings to the Bluetooth® adapter is ended normally (1 beep) or abnormally (3 beeps), or
 - there is a possibility of an abnormal setting because the "END" barcode from a batch-process barcode printed with a version of the configuration software that does not match the scanner firmware was scanned.
-

One-shot beep*2 (40 ms) or intermittent beep*2 (at 60 ms intervals) when:

- either one of the 1st and 2nd rows of an RSS-14 Stacked or RSS-14 Stacked Omnidirectional symbol is read. (Selecting an intermittent beep continues to beep as long as either one of the 1st and 2nd rows is left unread.) (Upon completion of a read, the beeper emits a short beep*1.)
-

- *1 The configuration software (ScannerSetting) provides three choices for the beeping time of a short beep--60, 80, and 120 ms.
- *2 The bar-coded parameter menu or the configuration software (ScannerSetting) provides three choices for the beeper type in reading RSS-14 Stacked and RSS-14 Stacked Omnidirectional symbols--One-shot beep, intermittent beep, and disabled.

The beeper can be disabled with the bar-coded parameter menu or configuration software (ScannerSetting). In any of the following cases, however, the beeper sounds regardless of the current beeper setting:

- When the scanner is being customized with the bar-coded parameter menus (Chapters 13 and 14).
- When the configuration software (ScannerSetting) starts up or accepts any new setting.
- When a batch-process bar code symbol is read.
- When the scanner has failed to save the parameter settings.
- When the Bluetooth® wireless link is established or broken.
- When transfer of Bluetooth® adapter parameter settings is normally ended.
- When the charge of the battery cartridge has lowered.

(2) Beeper volume

You can adjust the beeper volume to three level--High, medium and low, by using the bar-coded parameter menu or the configuration software (ScannerSetting). The factory default is High.

Each time the "Beeper volume" bar code is read, the beeper volume cycles as shown below.

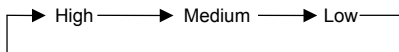

Turning the scanner power off does not affect this setting.

(3) Beeper frequency

The configuration software (ScannerSetting) provides the following three choices for beeper frequency.

- "Low: 2.0 kHz"
- "Medium: 4.0 kHz"
- "High: 4.3 kHz"

The factory default is Medium (4.0 kHz).

Turning the scanner power off does not affect this setting.

(4) Trigger timing for the reading completion beeper and indicator LED

The configuration software (ScannerSetting) provides the following two trigger timing choices for the reading completion beeper and indicator LED (blue).

- "Before data transmission": The trigger timing is when bar code scanning has been completed, regardless of whether the bar code data is normally transferred.
- "After data transmission": The trigger timing is when bar code scanning has been completed and the data has been normally transferred.

The factory default is "Before data transmission."

9.2 Indicator LED

The indicator LED lights or flashes in blue, green, red or orange to indicate the scanner status as described below.

Lights in **blue** when:

- a read of a bar code is successfully complete (Note that when the auto sensing mode switching function* is enabled, the indicator LED lights in green.),
 - the "Start setting" or "End setting" bar code symbol is read from the bar-coded parameter menu (given in Chapters 13 and 14),
 - bar code data read matches the master data in the data verification mode,
 - the auto sensing mode switching function* has switched the scanner to the currently selected trigger switch operating mode, or
 - switched to the trigger switch operating mode using the continuous reading mode switching function.
-

Flashes **blue** when:

- the scanner, as a master, is searching for a slave device for Bluetooth® wireless connection or
 - the scanner, as a slave, is waiting for a master to initiate Bluetooth® wireless connection.
-

Lights in **green** when:

- a processing started by magic key control has completed,
 - the scanner is ready to register master data in the data verification mode,
 - the scanner has read a bar code (except a master bar code for data verification) successfully with the auto sensing mode switching function* being enabled, or
 - the Bluetooth® wireless link is ready for use.
-

Lights in **red** when:

- a check digit error has occurred,
 - a bar code read has the wrong number of digits,
 - bar code data read does not match the master data in the data verification mode,
 - a master bar code read has the wrong number of digits in registration of master data,
 - the data retransfer function failed to transfer data,
 - an editing error has occurred in the specified data editing, resulting in no transfer,
 - the scanner failed to establish the Bluetooth® wireless link, or
 - pairing has failed in Bluetooth® authentication.
-

Flashes **red** when:

- no master data has been registered in the data verification mode,
 - the trigger switch was pressed with the "End operation" selected, or
 - the trigger switch was pressed with the Bluetooth® wireless link broken.
-

Lights in **orange** when:

- the auto sensing mode switching function* has switched the scanner to the auto sensing mode, or
 - switched to the continuous reading mode using the continuous reading mode switching function.
-

Flashes **orange** when:

- the charge of the battery cartridge has lowered.
-

*For the auto sensing mode switching function assigned to the magic key, refer to Chapter 6.

The indicator LED can be disabled with the bar-coded parameter menu or configuration software (ScannerSetting). In any of the following cases, however, the indicator LED comes on regardless of the current LED setting:

- When the scanner is being customized with the bar-coded parameter menus (Chapters 13 and 14).
- When the configuration software (ScannerSetting) starts up or accepts any new setting.
- When a batch-process bar code symbol is read.
- When a master bar code is being registered or the registration is complete.
- When any error has occurred during entry of a master bar code.
- When the verification result is a mismatch, the scanner is locked, or no master data has been registered in the data verification mode.
- When data retransfer with the magic key is complete or the previously sent data is not available at the time of data retransfer.
- When specific character transfer with the magic key is complete.
- When a hardware error has occurred.
- When the scanner has failed to save setting.
- When the Bluetooth® wireless link status is displayed.
- When the parameter transfer status from the scanner to the Bluetooth® adapter is displayed.
- When the charge of the battery cartridge has lowered.
- When the charging/discharging state is displayed.

9.3 Vibrator

The bar-coded parameter menu and configuration software (ScannerSetting) provide three configuration choices: indicating successful scanning (OK), indicating an error (NG), and disabled.

"OK" vibrations: The vibrator operates to indicate any of the following OK conditions.

- Successful transmission of the bar code data just read
 - In data verification mode, successful registration of master data
 - In the data verification mode, a match between the bar code data just read and master data registered
 - End of data transmission started by the data transfer or specific character transfer function
 - Scanning of "Start setting," "End setting," or parameter setting bar code from the bar-coded parameter menu (Chapters 13 and 14)
 - Start or end of parameter setting with the configuration software (ScannerSetting)
 - Scanning of a batch-process bar code symbol generated with the configuration software (ScannerSetting)
-

"NG" vibrations: The vibrator operates to indicate any of the following failure conditions.

- Wrong check digit(s) with check digits enabled
 - Wrong number of digits in data for new master data registration
 - In data verification mode, a mismatch between the bar code data just read and master data registered
 - Editing error in the specified data editing, resulting in no transfer
 - No ACK response received in the ACK/NAK mode
-

Note: It is recommended that the vibrator be disabled when the scanner is stationary to a stand.

10.1 Bluetooth® Interface

The bar-coded parameter menu and the configuration software (ScannerSetting) provide a choice of various communications conditions. Under the communications conditions you choose, bar code data read can be transferred to the external equipment or computer.

(1) Communications protocol

You can select either "Non-acknowledge mode," "ACK/NAK mode," or "Data packaging mode (to host or BA10-RKU)."

Non-acknowledge mode (default)

The scanner transfers bar code data read, regardless of the CTS signal level.

ACK/NAK mode

The scanner transfers bar code data read, regardless of the CTS signal level. After that, however, it waits for the response from the host and processes it. The configuration software (ScannerSetting) provides ACK/NAK timeout settings from 1 to 25 seconds in one-second increments. Models that do not support data packaging (packetizing) provide ACK/NAK timeout settings from 100 ms to 9.9 seconds in 100 ms increments.

ACK: Normal end

NAK: Retransfer

Data packaging mode

- To BA10-RKU

The scanner wraps the bar code data in a packet with a CRC for transfer to the Bluetooth® adapter. For further details, see Section 10.3.

- To host

The scanner wraps the bar code data in a packet with a CRC for transfer to a commercially available Bluetooth® device or other equipment. For further details, see Section 10.3.

(2) Timeout period for slave to wait for a connection request

The scanner, as a slave, waits for a connection request from the master for the specified timeout period--2 (default), 4, 10, or 30 minutes.

If the scanner cannot receive a connection request from the master within the specified timeout period, it switches to standby, the same status as the Bluetooth® wireless link has been broken.

(3) Automatic disconnection

If the Bluetooth® interface is not used for the specified timeout period, the scanner automatically breaks the Bluetooth® wireless link.

You can select the timeout period within the range from 5 to 640 minutes in 5-minute increments and also disable the automatic disconnection, using the configuration software (ScannerSetting).

(4) Clearing data after Bluetooth® wireless link breaks

A setting specifies whether the scanner clears transfer data if the Bluetooth® wireless link breaks for some reason or other during a data transfer. Specifying no, the default setting, transmits any data remaining in the transfer buffer once the Bluetooth® wireless link is re-established. Note, however, that, regardless of this and other operation settings for Bluetooth® wireless link breaks, transfer data lost in transit is not resent.

(5) Pairing

The scanner does not normally require pairing, but supports it if the target device so requires. Pairing involves sharing a PIN code. For further details, see Appendix 4.

10.2 Communication Format

10.2.1 Data transmission format

Select one of the following two data transmission formats.

Header	Code ID mark	Prefix	No. of digits				Bar code data	Suffix	Terminator
			n1	n2	n3	n4			

Header	Prefix	Code ID mark	No. of digits				Bar code data	Suffix	Terminator
			n1	n2	n3	n4			

(1) Header/Terminator

The following choices are available.

Header: None (default) or STX

Terminator: CR (default), LF, CR LF, ETX, or none

Note: Selecting none for a terminator automatically uses a CR terminator in the control command transmission format.

(2) Prefix/Suffix

Each of a prefix and suffix should be a maximum of eight bytes long and consist of ASCII characters (00h to FEh).

The default is no prefix/suffix. You can specify a prefix or suffix with the configuration software (ScannerSetting).

(3) Code ID mark

This optional field specifies a code ID mark identifying a bar code symbology. Six types of system-defined code ID marks are available as listed below. (Default: Type 1)

In addition, a user-defined code ID mark is also available for each of the bar code symbologies listed below. It should be a maximum of two bytes long and consist of ASCII characters (00h to FEh).

You can also select whether or not to transmit the code ID mark. (Default: No transmission)

Bar code symbologies	Code ID mark					
	Type 1 (DENSO 1)	Type 2 (DENSO 2)	Type 3	Type 4	Type 5 (AIM)*	Type 6 (AIM Type 2)*
UPC-A	A		C	A]X0	
UPC-E	C	E	D	A]X0	
EAN-13	A	F	B	A]E0	
EAN-8	B	FF	A	A]E4	
UPC-A with 2-digit add-on	A		F	A]X1]X3
UPC-A with 5-digit add-on	A		G	A]X2]X3
UPC-E with 2-digit add-on	C	E	H	A]X1]X3
UPC-E with 5-digit add-on	C	E	I	A]X2]X3
EAN-13 with 2-digit add-on	A	F	L	A]E1]E3
EAN-13 with 5-digit add-on	A	F	M	A]E2]E3
EAN-8 with 2-digit add-on	B	FF	J	A]E5	
EAN-8 with 5-digit add-on	B	FF	K	A]E6	
Standard 2of5 (short)	H		O	G]R0	
Standard 2of5 (normal)	H		O	G]S0	
Interleaved 2of5	I		N	F]Im	
Code 32	M		X	B]X0	
Code 39	M		V	B]Am	
Code 39 Full ASCII	M		W	B]Am	
CODABAR (NW-7)	N		R	C]Fm	
Code 93	L		U	E]G0	
Code 128	K		T	D]Cm	
EAN-128	W		k	K]C1	
MSI	P		Z	J]M1	
Plessey	T		a	T]P0	
RSS**	R		None	None]e0	

* Type 5 or 6 is a code ID mark system compliant with the AIM USA "Guidelines on Symbology Identifiers." The "m" suffix differs depending upon the data transmission format of each bar code symbology.

** This manual collectively calls RSS-14, RSS-14 Truncated, RSS-14 Stacked, RSS-14 Stacked Omnidirectional, and RSS Limited symbologies as RSS. (The RSS Expanded and RSS Expanded Stacked symbologies are not supported by this scanner.)

(4) Number of digits

This optional field specifies the number of digits (2 or 4 digits) of bar code data to transmit or disables the transmission (default). Note that UPC and EAN codes (except EAN-128) skip this field.

- n1 : thousands (0 to 9)
- n2 : hundreds (0 to 9)
- n3 : tens (0 to 9)
- n4 : units (0 to 9)

Selecting the two-digit length does not transmit n1 or n2.

(5) Bar code data

The following are the data transmission formats for bar code symbologies.

For the GTIN format conversion of UPC, EAN, Interleaved 2of5 (14-digit), RSS, and EAN-128, refer to Section 10.2.2.

UPC-A

0	Data (11-digit)	C/D
---	-----------------	-----

You can select whether or not to transmit the padding character "0," number system character (leading "0" in 11-digit data), and a check digit to the host.

UPC-E

When conversion to UPC-A is disabled (ZERO suppression format)

0	Data (6-digit)	C/D
---	----------------	-----

When conversion to UPC-A is enabled (ZERO insertion format)

0	Data (11-digit)	C/D
---	-----------------	-----

You can select whether or not to transmit the padding character "0," number system character (leading "0" in 11-digit data), and a check digit to the host.

The ZERO insertion format converts the data length to 11 according to the UPC standard.

EAN-13

Data (12-digit)	C/D
-----------------	-----

You can select whether or not to transmit the country code and a check digit to the host and enable conversion to ISBN/ISSN format.

Conversion, if enabled, produces ISBN/ISSN format according to the EAN standard.

EAN-8

Data (7-digit)	C/D
----------------	-----

You can select whether or not to add the five padding characters "0" (leading "0") to bring the total length to the same as EAN-13, as well as selecting whether or not to transmit a check digit.

UPC/EAN with ADD-ON

UPC/EAN data	ADD-ON data (2- or 5-digit)
--------------	-----------------------------

Standard 2of5, Interleaved 2of5

Data	C/D
------	-----

The Standard 2of5 and Interleaved 2of5 symbologies may or may not contain a check digit. You can select whether or not to check a check digit and transmit the check digit read.

(C/D: Check digit)

Codabar (NW-7)

Start code	Data	C/D	Stop code
------------	------	-----	-----------

The Codabar symbology may or may not contain a check digit. You can select whether or not to check a check digit and transmit the check digit read. There are two check digit methods available: modulo arithmetic-16 (MOD-16) and 7-check method.

You can also select whether or not to transmit start/stop codes, as well as selecting either lowercase letters "a/b/c/d" or uppercase letters "A/B/C/D" for start/stop codes.

Code 32

A	Data (8-digit)	C/D
---	----------------	-----

You can select whether or not to transmit the leading "A" in Code 32 data to the host and check a check digit.

Six-digit Code 39 data is converted to the 9-digit Code 32 format and then transmitted to the host when all of the following conditions are satisfied. Other number of digits of Code 39 data is transmitted in the original format without conversion.

<Conversion conditions>

- "Scanning Code 39" is enabled,
- "Conversion from Code 39 to Code 32 format" is enabled,
- Code 39 data is 6 digits long,
- Code 39 consists of any of "0 to 9" and "alphabets except A, E, I and O," and
- The conversion result is within the range from 0 to 99999999 excluding a check digit.

Code 39

Start code	Data	C/D	Stop code
------------	------	-----	-----------

The Code 39 symbology may or may not contain a check digit. You can select whether or not to check a check digit and transmit the check digit read.

You can also select whether or not to transmit start/stop codes (which are "*") or to enable conversion to Code 39 Full ASCII or Code 32 format.

Code 93, Code 128, EAN-128

Data

When Code 128 is specified, data in the following format is regarded as an EAN-128 code.

Start code	FNC1	Data	C/D	Stop code
------------	------	------	-----	-----------

You can select whether to convert an FNC1 (if contained) to GS (1Dh) and transfer or not to transfer an FNC1.

MSI, Plessey

Data	C/D
------	-----

RSS (Note)

Data

(Note) This manual collectively calls RSS-14, RSS-14 Truncated, RSS-14 Stacked, RSS-14 Stacked Omnidirectional, and RSS Limited symbologies as RSS. (The RSS Expanded and RSS Expanded Stacked symbologies are not supported by this scanner.)

10.2.2 GTIN Format Conversion

If the GTIN format conversion function is enabled, EAN-13, EAN-8, UPC-A, UPC-E and Interleaved 2of5 (14-digit) codes can be output in GTIN format, and GTIN format RSS and EAN-128 codes can be output by EAN/JAN (product code format).

(1) Conversion of EAN/UPC to GTIN format

If converting to GTIN format, it is possible to select from conversion to 16 digits or conversion to 14 digits, and to select the transmitted PI from "0" to "9". Furthermore, by selecting prohibition of conversion to GTIN format, it is possible to prohibit only the conversion of EAN/UPC codes to GTIN format.

EAN-13 (16-digit)	01	PI	Data (12-digit)	C/D
(14-digit)	PI	Data (12-digit)	C/D	

EAN-8 (16-digit)	01	PI	00000	Data (7-digit)	C/D
(14-digit)	PI	00000	Data (7-digit)	C/D	

UPC-A (16-digit)	01	PI	0	Data (11-digit)	C/D
(14-digit)	PI	0	Data (11-digit)	C/D	

UPC-E (16-digit)	01	PI	0	Data (11-digit)	C/D
(14-digit)	PI	0	Data (11-digit)	C/D	

EAN-13 with add-on (16-digit)	01	PI	0	Data (11-digit)	C/D	ADD-ON data (2- or 5-digit)
(14-digit)	PI	0	Data (11-digit)	C/D	ADD-ON data (2- or 5-digit)	

EAN-8 with add-on (16-digit)	01	PI	0	Data (11-digit)	C/D	ADD-ON data (2- or 5-digit)
(14-digit)	PI	0	Data (11-digit)	C/D	ADD-ON data (2- or 5-digit)	

UPC-A with add-on (16-digit)	01	PI	0	Data (11-digit)	C/D	ADD-ON data (2- or 5-digit)
(14-digit)	PI	0	Data (11-digit)	C/D	ADD-ON data (2- or 5-digit)	

UPC-E with add-on (16-digit)	01	PI	0	Data (11-digit)	C/D	ADD-ON data (2- or 5-digit)
(14-digit)	PI	0	Data (11-digit)	C/D	ADD-ON data (2- or 5-digit)	

UPC-E code data is converted to the ZERO insertion format and then to the GTIN format.

(C/D: Check digit)
(PI: Package indicator)

(2) Conversion of Interleaved 2of5 (14-digit) to GTIN format

In the case of Interleaved 2of5 symbology, conversion to the GTIN format applies to 14-digit data. Other number of digits of data is transmitted in the original format.

Interleaved 2of5 (14-digit)	01	Data (13-digit)	C/D
	01	Data (14-digit)	

(C/D: Check digit)

Check digits are transmitted regardless of the setting.

(3) Conversion of GTIN format RSS/EAN-128 to EAN/JAN

If converting to EAN/JAN (product code format), it is possible to select from conversion to 14 digits or conversion to 13 digits. Furthermore, by selecting prohibition of conversion to EAN/JAN, it is possible to prohibit only the conversion of GTIN format RSS/EAN-128 codes to EAN/JAN. Conversion provides two choices--14- and 13-digit EAN formats.

RSS, EAN-128 (14-digit)	PI	Data (12-digit)	C/D
(13-digit)	Data (12-digit)	C/D	

(C/D: Check digit)
(PI: Package indicator)

10.3 Data Packaging (Packetizing)

Data packaging is available to boost the reliability of data transfers over the Bluetooth® wireless link from the scanner to the Bluetooth® adapter (BA10-RKU), commercially available Bluetooth® device, or other target device.

Data packaging wraps the bar code data in packets with the following format. After sending a packet, the scanner waits for a response from the target device. ACK indicates a successful transfer; NAK represents a request to resend.

The scanner configuration software (ScannerSetting) provides ACK/NAK timeout settings from 1 to 25 seconds in one second intervals.

If there is no response within the specified time limit, the scanner sounds the error beep to indicate that the data transfer was unsuccessful. The scanner cannot read in a new bar code while it is waiting for a response.

This functionality provides a scanner operator working some distance from the host with better information as to whether the bar code data has been correctly transmitted to the host. Note, however, that wireless communications are such that the scanner can sometimes fail to receive ACK (or NAK) responses even when the data has been correctly transmitted. It is therefore important to use the scanner in an environment supporting stable wireless communications.

■ Data transmission format

Header		Number of data bytes	Spare	Transfer data	CRC		Terminator	
DLE	STX				Lower half	Upper half	DLE	ETX

The following describes each field in detail.

(1) Header (2 bytes)

This data sequence indicates the start of data packaging (packetizing).

(2) Number of data bytes (2 bytes)

This specifies the number of data bytes in the packet. This number includes everything from the header to the terminator.

(3) Spare (2 bytes)

This field is for future expansion. The value is currently fixed at 0000h.

(4) Transfer data

This is the data before packetized.

(5) CRC (2 bytes)

This 16-bit CRC is calculated from the "Number of data bytes" through "Transfer data" using the CCITT CRC polynomial $x^{16}+x^{12}+x^5+1$. The two bytes appear in little-endian order: LSB first, MSB second.

(6) Terminator (2 bytes)

This data sequence indicates the end of data packaging (packetizing).

Note: If DLE (10h) is contained in the data anywhere else other than in the header or terminator, it will be preceded by another DLE in data transfer. If the connection target is other than the Bluetooth® adapter in data packaging, it is necessary to delete the added DLE in CRC calculation or data retrieval.

Using scanner connected to Bluetooth® adapter

Scanner settings:

Data packaging mode (to BA10-RKU)

Bluetooth® adapter settings:

GT10 series as target

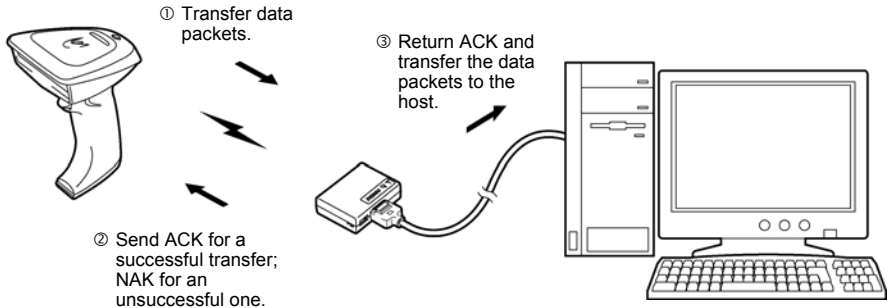

Using scanner connected to other than Bluetooth® adapter

Scanner settings:

Data packaging mode (to host)

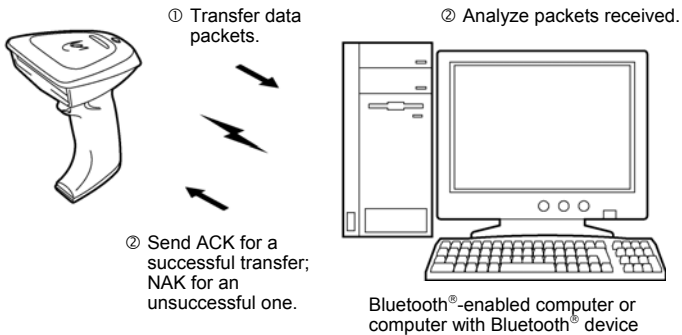

Example of analysis for packet received

Data received (hexadecimal)

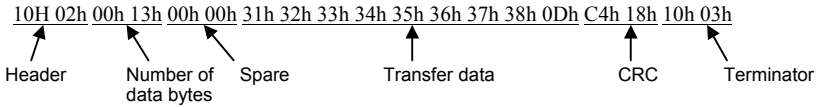

- (1) Compare data lengths.

Data length received in packet: 0013h = 19 bytes

Data received in packet: 19 bytes

- (2) Compare CRCs.

- 1) Initialize CRC to 0.
- 2) Retrieve the first data byte (00h).
- 3) Shift the current CRC value one bit to the left. If the shift produces overflow, XOR the result with 1021h.
- 4) Shift the data byte one bit to the left. If the shift produces overflow, XOR the current CRC value with 0001h.
- 5) Repeat steps 3) and 4) a total of 8 times.
- 6) Retrieve the second data byte (13h).
- 7) Repeat steps 3) and 4) a total of 8 times.
- 8) Repeat this calculation through to the final byte.
- 9) Finally repeat the calculation for the two bytes (C4h 18h) in the CRC storage area, but reverse them first because the 16-bit CRC is stored in little-endian order.

Data	CRC
--	0000h
00h	0000h
13h	1300h
00h	0013h
00h	221Ah
31h	8EF9h
32h	58C0h
33h	F554h
34h	2054h
35h	2181h
36h	A3A0h
37h	92A9h
38h	0059h
0Dh	C244h
18h	1CE2h
C4h	0000h

- (3) A result of 0000h indicates a successful transfer; a nonzero one, an error.

Chapter 11 Charging and Replacing the Battery Cartridge

11.1 Charging and Discharging the Battery Cartridge

When the battery cartridge charge drops to a level requiring recharging, a warning sounds and the indicator LED starts flashing orange once every five seconds. This flashing continues until the scanner is recharged. Recharge the scanner as promptly as possible.

Continued use without charging sounds another warning and the scanner turns itself off. Recharge the scanner immediately.

Some heat generation in the scanner or charger during charging is perfectly normal.

Note: Some scanner firmware has a different response pattern, intermittently sounding a warning at one-second intervals for 20 seconds and then cutting the power to the scanner. In that case, recharge the scanner immediately.

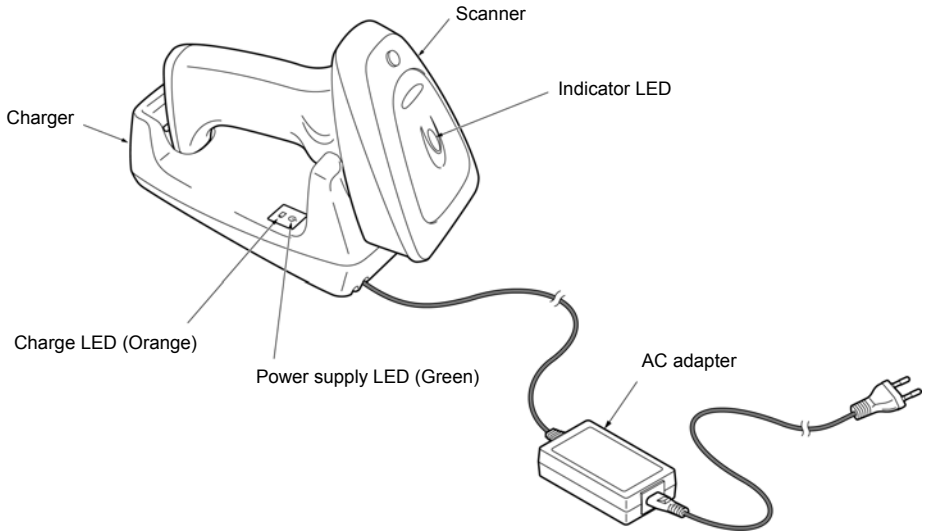

■ Important notes on care and handling

- Use the charger only in locations satisfying the following conditions.
 - Ambient temperature of 0 to 40°C (Ambient temperature of 10 to 30°C recommended.)
 - Humidity of 20% to 80%
 - No dust or excessive vibration
 - No splashing of water or other liquids
- Do not leave the charger in direct sunlight, in an automobile, or other location exposed to high temperatures.
- Keep the charger away from telephones, television sets, radios, and other equipment sensitive to electromagnetic noise.
- Disconnect the charger from the electrical outlet when not in use.
- Occasionally clean the charging pins with a dry cotton swab or similar material. Allowing foreign matter to accumulate can interfere with proper charging.
- Sudden temperature fluctuations sometimes interfere with proper charging.
- There may be times when the charger charge LED (orange) turns OFF and the scanner indicator LED flashes red after charging is commenced. This indicates that the rechargeable battery protection function has been activated and charging can no longer be continued due to such reasons as sudden temperature fluctuations. Either change the location or try again once the temperature has stabilized.

■ Charging procedure

- (1) Connect the AC adapter to the charger and then plug it into an electrical outlet.
Confirm that the green power supply LED lights.
- (2) Place the scanner in the charger.
The charger's orange charge LED lights and the scanner's indicator LED turns red, indicating the start of charging.
When charging is complete, approximately 2.5 hours later, (if the battery cartridge has been fully discharged), the charger's orange charge LED goes off and the scanner's indicator LED turns green.
- (3) Remove the scanner from the charger and unplug the AC adapter from the electrical outlet

Operation and Status	Charger's charge LED (Orange)	Scanner's indicator LED
Place the scanner in the charger.	On	Red
↓		
Charging starts.	On	Red
↓ Approximately 2.5 hours later		
Charging complete. (Trickle charging*)	Off	Green

* "Trickle charging" is a slow continuous charge for a battery, which compensates for the slight amount of discharge happening even when the battery is not in use.

Note: Rechargeable battery cartridges may become inactive if left for long periods of time without use. Use after repeatedly charging and discharging (refreshing) several times.

■ Discharging and recharging (refreshing) procedure

The battery cartridge uses a Ni-MH battery. If it undergoes many cycles of imperfect charging and discharging (e.g., one-hour recharge followed by one-hour use), the operation period will become abnormally shortened before the service life is really expired, just as the battery memorizes the usage conditions. It is called "Memory Effect" or "Memory Accumulation." The memory effect can be avoided by discharging a Ni-MH battery fully before recharging (i.e. refreshing) using the following procedure.

- (1) Connect the AC adapter to the charger and then plug it into an electrical outlet.
Confirm that the green power supply LED lights.
- (2) Place the scanner in the charger.
The charger's orange charge LED lights and the scanner's indicator LED turns red, indicating the start of charging.
- (3) Hold down the scanner's trigger switch for approximately 10 seconds.
The charge LED goes off and the indicator LED turns orange, indicating the start of discharging.
When discharging is complete, approximately 10 hours later (if the battery was fully charged), charging automatically starts. The orange charge LED lights and the indicator LED turns red.
When charging is complete, approximately 2.5 hours later from the start of recharging, the charge LED goes off and the indicator LED turns green.
- (4) Remove the scanner from the charger and unplug the AC adapter from the electrical outlet.

Operation and Status	Charger's charge LED (Orange)	Scanner's indicator LED
Place the scanner in the charger.	On	Red
↓		
Hold down the trigger switch for approximately 10 seconds.	Off	Orange
↓ Discharging		
Charging starts.	On	Red
↓ Approximately 2.5 hours later		
Charging complete.	Off	Green

11.2 Replacing the Battery Cartridge

The rechargeable battery cartridge is a consumable part with a finite service life. It is time to replace it when a full charge lasts a significantly shorter time than previously. Note that the service life varies with usage conditions

Follow the replacement procedure given below also when it is necessary to take the battery cartridge out of the scanner due to any scanner trouble.

- (1) Remove the screw that secures the battery cover.
- (2) Open the battery cover gently that is connected with the cable.

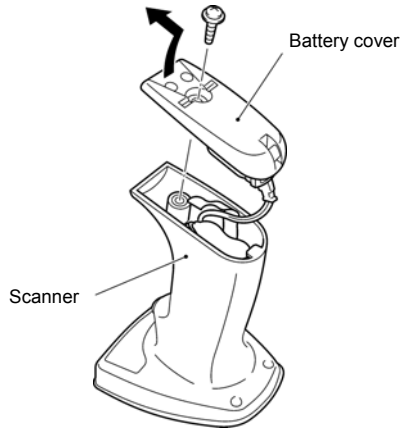

- (3) Pull up the battery pull strap to take the battery cartridge out of the scanner.
- (4) Disconnect the battery cable connector.

Note: When disconnecting the cable connector, be sure to hold the connector housings as shown below. Do not pull the cables; doing so will result in broken wires.

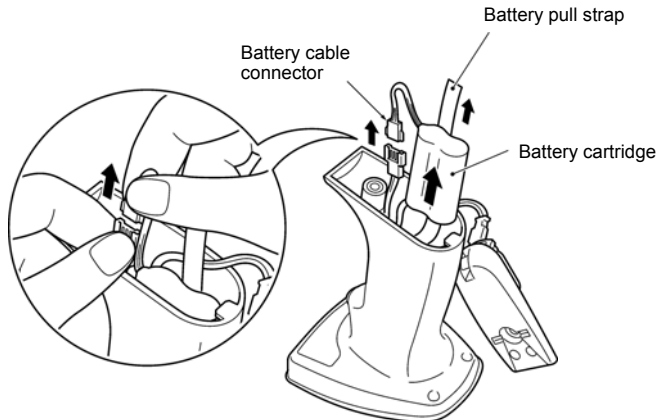

(5) Connect a new battery cartridge to the battery cable connector.

Note: Do not peel off the protection film covering a battery cartridge.

(6) Insert the new battery cartridge into the scanner so that the battery pull strap is routed below the battery cartridge as shown below.

(7) Route the cables into the space around the battery cartridge to prevent them from getting pinched between the battery cover and the case, and then close the battery cover and secure it with the screw.

Note: After loading a new battery cartridge, be sure to charge it for at least two hours.

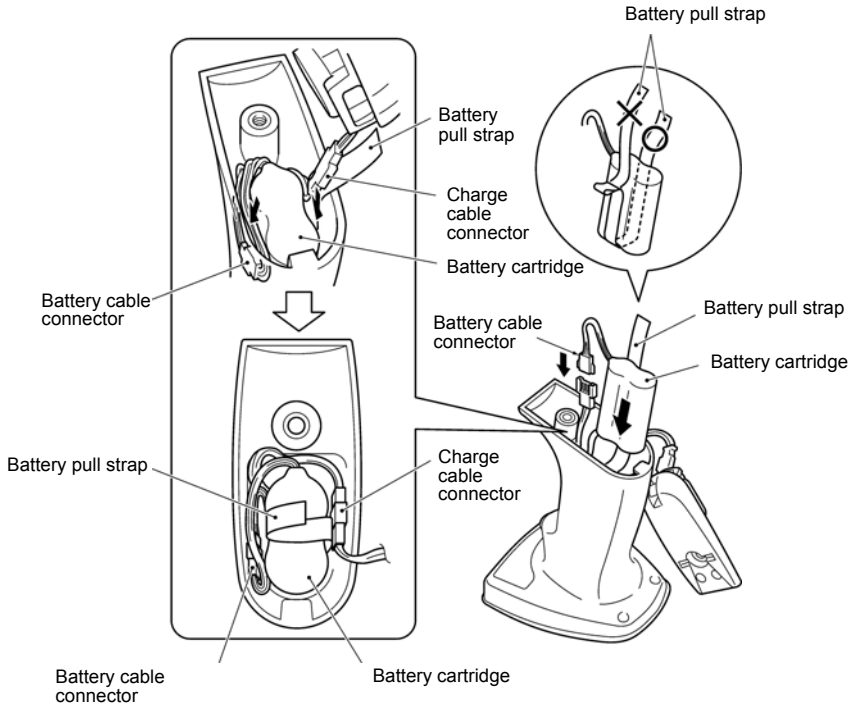

11.3 Recycling the Battery Cartridge

Battery Cartridge Recycling Request

- This product uses a Nickel-metal hydride battery that contains scarce, recyclable resources. We kindly ask for your cooperation in recycling to ensure reuse of these resources.



The crossed-out wheeled bin is applicable for EU member status only.

- Used battery cartridges must not be disposed of as combustibles.
- Contact your nearest rechargeable battery recycling centre or local sales office for information on disposal procedures.
- When disposing of used battery cartridges at your nearest recycle centre, cover the terminals with vinyl tape to insulate and protect from overheating or fire due to a short-circuit.
- Never disassemble battery cartridges.

Chapter 12 Parameters and Defaults

The tables below list the parameters and their defaults. Those parameter settings can be changed with the bar-coded parameter menu and configuration software (ScannerSetting), except **shadowed** ones only with the configuration software.

When the scanner leaves the factory, all of these parameters are set to defaults.

(1) Bluetooth® communications parameters

Items	Parameters	Defaults	Refer to:
Communications protocol	Non-acknowledge mode	√	Section 10.1 (1)
	ACK/NAK mode		
	Data packaging mode (to host)		
	Data packaging mode (to BA10-RKU)		
Header	None	√	Section 10.2.1 (1)
	STX		
Terminator	ETX		
	CR	√	
	LF		
	CR LF		
ACK/NAK response time	1 to 25 seconds (0.1 to 9.9 seconds on models that do not support data packaging)	1 s	Section 10.1 (1)
	As a master		Section 2.2
As a slave	√		
Timeout period for slave to wait for a connection request	2 minutes	√	Section 10.1 (2)
	4 minutes		
	10 minutes		
	30 minutes		
Timeout period for automatic disconnection of the Bluetooth® wireless link	5 to 640 minutes	485 min.	Section 10.1 (3)
	Disable automatic disconnection		
Clear the transfer buffer when the Bluetooth® link breaks	Enable		Section 10.1 (4)
	Disable	√	

■: Can be changed only with the configuration software.

(2) Data transmission format and bar code symbologies

Items	Parameters	Defaults	Refer to:
Prefix transmission	Enable		Section 10.2.1 (2)
	Disable	√	
Suffix transmission	Enable		
	Disable	√	
Data editing	Enable		Chapter 8
	Disable	√	
Transmission of code ID mark	Enable		Section 10.2.1 (3)
	Disable	√	
Code ID mark position	Before prefix		
	After prefix	√	
Code ID mark	Type 1 (DENSO 1)	√	
	Type 2 (DENSO 2)		
	Type 3		
	Type 4		
	Type 5 (AIM)		
	Type 6 (AIM Type 2)		
	User-defined		
Transmission of the number of digits (not applicable to UPC/EAN codes)	Enable, in 4 digits		Section 10.2.1 (4)
	Enable, in 2 digits		
	Disable	√	
GTIN format conversion	Enable		Section 10.2.2
	Disable	√	
Conversion type from EAN/UPC/ Interleaved 2of5 (14-digit) to GTIN format	16-digit GTIN format	√	Section 10.2.2 (1)
	14-digit GTIN format		
	Disable conversion		
Conversion type from RSS/EAN-128 in GTIN format to EAN format	14-digit EAN format	√	Section 10.2.2 (2)
	13-digit EAN format		
	Disable conversion		
Prefix PI in conversion from EAN/UPC/ Interleaved 2of5 (14-digit) to GTIN format	0 to 9	0	Section 10.2.2 (1)

 : Can be changed only with the configuration software.

Items	Parameters	Defaults	Refer to:
Scanning UPC-A, UPC-E, EAN-13 and EAN-8	Enable	√	
	Disable		
Scanning UPC/EAN with 2-digit add-on	Enable		
	Disable	√	
Scanning UPC/EAN with 5-digit add-on	Enable		
	Disable	√	
Transmission of the number system character of UPC-A	Enable	√	Section 10.2.1 (5)
	Disable		
Transmission of the number system character of UPC-E	Enable	√	
	Disable		
Transmission of padding characters "0" for UPC-A	Enable	√	
	Disable		
Transmission of padding characters "0" for UPC-E	Enable		
	Disable	√	
Transmission of a check digit for UPC-A	Enable	√	
	Disable		
Transmission of a check digit for UPC-E	Enable	√	
	Disable		
Transmission of a check digit for EAN-13	Enable	√	
	Disable		
Transmission of a check digit for EAN-8	Enable	√	
	Disable		
Transmission format of EAN-8 (Conversion to EAN-13)	Enable conversion		
	Disable conversion	√	
Transmission format of UPC-E (Conversion to UPC-A)	Enable conversion		
	Disable conversion	√	
Transmission of country code for EAN-13	Enable	√	Section 10.2.1 (5) (See Note 1.)
	Disable		
Conversion to ISBN/ISSN format for EAN-13	Enable		Section 10.2.1 (5)
	Disable	√	

(Note 1) A country code is in the upper two digits of the prefix character field in EAN-13.

: Can be changed only with the configuration software.

Standard 2of5

Items	Parameters	Defaults	Refer to:
Scanning Standard 2of5	Enable, without C/D		
	Enable, with C/D		
	Disable	√	
Minimum number of digits readable for Standard 2of5	1 to 99 digits	3 digits	(See Note 2.)
Maximum number of digits readable for Standard 2of5		99 digits	
Transmission of a check digit for Standard 2of5	Enable	√	Section 10.2.1 (5) (See Note 3.)
	Disable		
Specification of the number of digits for Standard 2of5, by bar code scanning	Enable		Section 7.2
	Disable	√	

Interleaved 2of5

Items	Parameters	Defaults	Refer to:
Scanning Interleaved 2of5	Enable, without C/D	√	
	Enable, with C/D		
	Disable		
Minimum number of digits readable for Interleaved 2of5	2 to 99 digits	4 digits	(See Note 2.)
Maximum number of digits readable for Interleaved 2of5		99 digits	
Transmission of a check digit for Interleaved 2of5	Enable	√	Section 10.2.1 (5) (See Note 3.)
	Disable		
Specification of the number of digits for Interleaved 2of5, by bar code scanning	Enable		Section 7.2
	Disable	√	

Codabar (NW-7)

Items	Parameters	Defaults	Refer to:
Scanning Codabar (NW-7)	Enable, without C/D	√	
	Enable, with C/D		
	Disable		
Minimum number of digits readable for Codabar (NW-7)	3 to 99 digits (including start/stop codes)	4 digits	(See Note 2.)
Maximum number of digits readable for Codabar (NW-7)		99 digits	
Transmission of a check digit for Codabar (NW-7)	Enable	√	Section 10.2.1 (5) (See Note 3.)
	Disable		

(Note 2) The setting range differs from the number of digits that the scanner can actually read.

(Note 3) To enable the transmission of a check digit, it is also necessary to select the "Enable, with C/D" parameter for scanning.

■: Can be changed only with the configuration software.

Item	Parameters	Defaults	Refer to:
Check digit method for Codabar (NW-7)	MOD-16	√	Section 10.2.1 (5)
	7-check method		
Transmission of start/stop codes for Codabar (NW-7)	Transmit a/b/c/d		
	Transmit A/B/C/D		
	Disable	√	

Code 32

Item	Parameters	Defaults	Refer to:
Conversion from Code 39 to Code 32 format	Enable		Section 10.2.1 (5)
	Disable	√	
Transmission of leading "A" in Code 32 data	Enable		
	Disable	√	
Checking of a check digit in Code 32 data	Enable		
	Disable	√	

Code 39

Item	Parameters	Defaults	Refer to:
Scanning Code 39	Enable, without C/D	√	
	Enable, with C/D		
	Disable		
Minimum number of digits readable for Code 39	1 to 99 digits (excluding start/stop codes)	1 digit	(See Note 2.)
Maximum number of digits readable for Code 39		99 digits	
Transmission of a check digit for Code 39	Enable	√	Section 10.2.1 (5) (See Note 3.)
	Disable		
Transmission of start/stop codes for Code 39	Enable		Section 10.2.1 (5)
	Disable	√	
Conversion to Full ASCII for Code 39	Enable		
	Disable	√	

Code 93

Items	Parameters	Defaults	Refer to:
Scanning Code 93	Enable		
	Disable	√	
Minimum number of digits readable for Code 93	1 to 99 digits (excluding start/stop codes and 2-digit C/D)	1 digit	(See Note 2.)
Maximum number of digits readable for Code 93		99 digits	

(Note 2) The setting range differs from the number of digits that the scanner can actually read.

(Note 3) To enable the transmission of a check digit, it is also necessary to select the "Enable, with C/D" parameter for scanning.

■: Can be changed only with the configuration software.

Code 128, EAN-128

Items	Parameters	Defaults	Refer to:
Scanning Code 128	Enable	√	
	Disable		
Scanning EAN-128	Enable	√	
	Disable		
Minimum number of digits readable for Code 128 and EAN-128	1 to 99 digits (excluding 1-digit C/D)	1 digit	(See Note 2.)
Maximum number of digits readable for Code 128 and EAN-128		99 digits	
Transmission of FNC1 for Code 128 and EAN-128	Transmit after conversion to GS	√	Section 10.2.1 (5)
	Disable		

MSI, Plessey

Items	Parameters	Defaults	Refer to:
Scanning MSI	Enable		
	Disable	√	
Minimum number of digits readable for MSI	3 to 99 digits (including 2-digit C/D)	3 digits	(See Note 2.)
Maximum number of digits readable for MSI		99 digits	
Scanning Plessey	Enable		
	Disable	√	
Minimum number of digits readable for Plessey	4 to 99 digits (including 2-digit C/D)	4 digits	(See Note 2.)
Maximum number of digits readable for Plessey		99 digits	

RSS

Item	Parameters	Defaults	Refer to:
Scanning RSS-14, RSS-14 Truncated, RSS-14 Stacked, RSS-14 Stacked Omnidirectional	Enable		
	Disable	√	
Scanning RSS Limited	Enable		
	Disable	√	

(Note 2) The setting range differs from the number of digits that the scanner can actually read.

: Can be changed only with the configuration software.

(3) Trigger switch control and magic key control

Items	Parameters	Defaults	Refer to:
Trigger switch control	Auto-off mode 1		Section 5.1
	Auto-off mode 2		
	Momentary switching mode 1	√	
	Momentary switching mode 2		
	Continuous reading mode		
	Auto sensing mode		
Scanning period in auto-off mode 1	1 sec.		Section 5.1
	2 sec.		
	3 sec.		
	4 sec.		
	5 sec.	√	
Scanner sensibility level in auto sensing mode	High (Sensitive)		Section 5.3
	Medium	√	
	Low (Insensitive)		
Magic key control	Illumination switching function		Chapter 6
	Data retransfer function		Chapter 6
	Specific character transfer function		
	Ready/standby switching function		
	Auto sensing mode switching function		
	Continuous reading mode switching function		
	No function	√	

: Can be changed only with the configuration software.

(4) Beeper, indicator LED and vibrator

Items	Parameters	Defaults	Refer to:
Beeper	Enable	√	Section 9.1
	Disable		
Beeping time of a short beep	Short (60 ms)	√	Section 9.1
	Medium (80 ms)		
	Long (120 ms)		
Beeper volume	High	√	Section 9.1
	Medium		
	Low		
Beeper frequency	Low (2.0 kHz)		Section 9.1
	Medium (4.0 kHz)	√	
	High (4.3 kHz)		
Trigger timing for the reading completion beeper and indicator LED	Before data transmission	√	
	After data transmission		
Beeper when reading RSS-14 Stacked and RSS-14 Stacked Omnidirectional	Enable	√	Section 9.1
	Disable		
Beeping pattern when reading RSS-14 Stacked and RSS-14 Stacked Omnidirectional	One-shot beep	√	
	Intermittent beep		
Indicator LED	Enable	√	Section 9.2
	Disable		
Vibrator	"OK" vibrations	√	Section 9.3
	"NG" vibrations		
	Disable		

The beeper and indicator LED parameters above apply to reading confirmation. They do not affect the functions of the beeper and indicator LED used for confirmation of wireless link's connection/disconnection and verification result.

: Can be changed only with the configuration software.

(5) Data verification mode

Items	Parameters	Defaults	Refer to:
Scanning modes	Regular read mode	√	Section 7.1
	Data verification mode		
Data verification type	2-point verification		
	n-point verification	√	
Verification retry after mismatch in 2-point verification	Disable	√	
	Enable		
Verification result output in data verification mode (Report of match/mismatch status)	Disable transmission/ Disable transmission	√	
	Enable bar code data transmission/ Disable transmission		
	Enable bar code data transmission/ Enable NG transmission		
	Enable OK transmission/ Enable NG transmission		
Verification start position in data verification mode	1st character	√	
	2nd character		
	3rd character		
	4th character		
	5th character		
	6th character		
	7th character		
Number of characters to verify, starting from the verification start position	1 character		
	2 characters		
	3 characters		
	4 characters		
	5 characters		
	6 characters		
	7 characters		
	Not specified	√	
Scan lock in data verification mode	Enable		
	Disable	√	
Reading with scanner mounted on charger	Enable		Section 5.4
	Disable	√	

(6) Notification of a scanning failure under software control

Items	Parameters	Defaults	Refer to:
Notification of a scanning failure that occurred under software control	Enable CAN (18h) transmission	√	Section 5.2
	Enable "ERROR" transmission		
	Disable transmission		

■: Can be changed only with the configuration software.

(7) Speed-/depth-priority scanning

Items	Parameters	Defaults	Refer to:
Speed-/depth-priority scanning	Speed-priority scanning	√	Chapter 3 (See Note 4.)
	Depth-priority scanning	√	

(Note 4) The default is speed-priority scanning for the GT10B-SB, and depth-priority scanning for the GT10B-LB.

(8) Switching to sleep mode for power saving

Items	Parameters	Defaults	Refer to:
Transition period from standby to sleep mode after completion of scanning	Immediately	√	Chapter 3
	5 seconds		
	15 seconds		
	30 seconds		
	1 minute		
	5 minutes		
	Disable		

: Can be changed only with the configuration software.

(9) For Bluetooth® adapter: Bluetooth® communications parameters

Items	Parameters	Defaults	Refer to:
Clear the transfer buffer when the Bluetooth® link is broken	Enable		
	Disable	√	
Connection target	GT10 series	√	
	Others		
Reception of split packets	Enable	√	
	Disable		

(10) For Bluetooth® adapter: Interfaces

Items	Parameters	Defaults	Refer to:
Interface	USB keyboard interface	√	
	USB-COM interface		
	RS-232C interface		
	PS/2 keyboard interface		

(11) For Bluetooth® adapter: USB keyboard interface communications parameters

The following settings take effect only when the USB keyboard interface is set up.

Items	Parameters	Defaults	Refer to:
Caps mode	Auto setting	√	
	Manual setting		
Caps Lock of host's keyboard	ON (Uppercase letter)		(See Note 5.)
	OFF (Lowercase letter)	√	
Keyboard type	U.S. English (101 keyboard)	√	
	Germany (102 keyboard)		
	French (102 keyboard)		
	U.K. English (102 keyboard)		
	Italian (102 keyboard)		
	Swedish (102 keyboard)		
Data transmission interval	Japanese (106 keyboard)		
	3 ms	√	
	6 ms		
	10 ms		
	16 ms		
	30 ms		
	50 ms		
100 ms			

(Note 5) Select the Caps Lock state that matches the host's keyboard state.

Items	Parameters	Defaults	Refer to:
Numeric key type	Inboard numeric keys	√	(See Note 6.)
	Numeric keypad		
Special key transmission	Enable		(See Note 7.)
	Disable	√	

(Note 6) When selecting "Numeric keypad," set the host's Num Lock to ON.

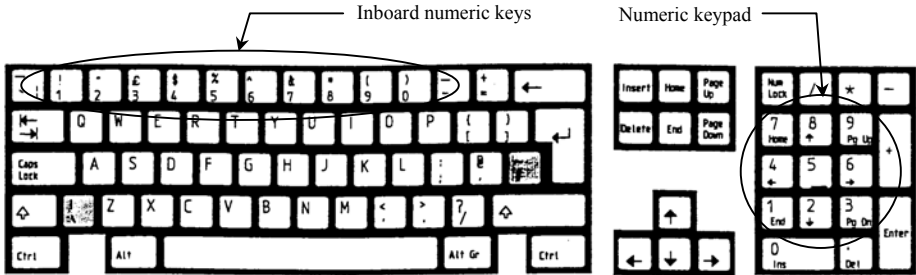

U.S. English (101 key type)

(Note 7) Special key transmission applies to the fields except header and terminator in the data transmission format. Enabling this function substitutes E7h to FDh data with the special keys as listed below and transmits the substituted data to the host. The Left SHIFT, Left CTRL, and Left ALT are transmitted as a simultaneous depression with the subsequent character or key.

Lower \ Upper	E	F
0		↓
1		F1
2		F2
3		F3
4		F4
5		F5
6		F6
7	Left SHIFT	F7
8	Left CTRL	F8
9	Left ALT	F9
A	TAB	F10
B	ESC	F11
C	ENTER	F12
D	←	Right CTRL
E	↑	
F	→	

Special Key Substitution Table

(12) For Bluetooth® adapter: USB-COM interface communications parameters

The following settings take effect only when the USB-COM interface is set up.

Items	Parameters	Defaults	Refer to:
CTS signal monitor	Enable	√	
	Disable		

(13) For Bluetooth® adapter: RS-232C interface communications parameters

The following settings take effect when the RS-232C interface is set up.

Items	Parameters	Defaults	Refer to:
Transmission speed	1200 bps		
	2400 bps		
	4800 bps		
	9600 bps	√	
	14400 bps		
	19200 bps		
	38400 bps		
	57600 bps		
	115200 bps		
Data bits	7 bits		
	8 bits	√	
Parity	Odd		
	Even		
	None	√	
Stop bit(s)	1 bit	√	
	2 bits		
CTS signal monitor	Enable	√	
	Disable		

(14) For Bluetooth® adapter: PS/2 keyboard interface communications parameters

The following settings take effect when the PS/2 keyboard interface is set up.

Items	Parameters	Defaults	Refer to:
Keyboard connection type	With external keyboard	√	
	Without external keyboard		
Caps Lock of host's keyboard	ON (Uppercase letter)		(See Note 8.)
	OFF (Lowercase letter)	√	
Num Lock of host's keyboard	ON	√	
	OFF		
Keyboard type	U.S. English (101 keyboard)	√	
	Germany (102 keyboard)		
	French (102 keyboard)		
	U.K. English (102 keyboard)		
	Italian (102 keyboard)		
	Swedish (102 keyboard)		
	Japanese (106 keyboard)		
	IBM 5576-001		
Data transmission interval	1 ms	√	
	5 ms		
	10 ms		
	15 ms		
	30 ms		
	50 ms		
	100 ms		
Numeric key type	Inboard numeric keys	√	(See Note 6.)
	Numeric keypad		

(Note 6) When selecting "Numeric keypad," set the host's Num Lock to ON.

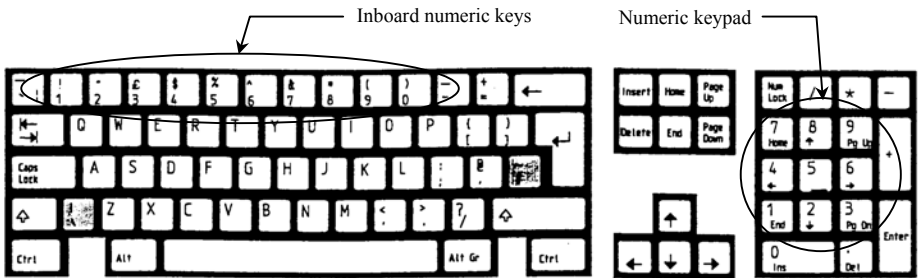

U.S. English (101 key type)

(Note 8) Select the Caps Lock and Num Lock states that match the host's keyboard states.

Items	Parameters	Defaults	Refer to:
Special key transmission	Enable		(See Note 7.)
	Disable	√	

(Note 7) Special key transmission applies to the fields except header and terminator in the data transmission format. Enabling this function substitutes E7h to FDh data with the special keys as listed below and transmits the substituted data to the host.

The Left SHIFT, Left CTRL, and Left ALT are transmitted as a simultaneous depression with the subsequent character or key.

Lower \ Upper	E	F
0		↓
1		F1
2		F2
3		F3
4		F4
5		F5
6		F6
7	Left SHIFT	F7
8	Left CTRL	F8
9	Left ALT	F9
A	TAB	F10
B	ESC	F11
C	ENTER	F12
D	←	Right CTRL
E	↑	
F	→	

Special Key Substitution Table

(15) For Bluetooth® adapter: Substitution of header/terminator for PS/2 and USB keyboard interfaces

The following settings take effect only when the PS/2 or USB keyboard interface is set up.

Items	Parameters	Defaults	Refer to:
Substitution of header	Enable		
	Disable	√	
Search string for header	Single ASCII character (00h to 7Fh)		
Substitution string for header	Max. 4 ASCII characters (00h to 7Fh and E7h to FDh)		
Substitution of terminator	Enable	√	
	Disable		
Search string for terminator	Single ASCII character (00h to 7Fh)	CR (0Dh)	
Substitution string for terminator	Max. 4 ASCII characters (00h to 7Fh and E7h to FDh)	Enter (ECh)	

: Can be changed only with the configuration software.

Chapter 13 Bar-Coded Parameter Menu for Scanners

13.1 Parameter Setting Procedure Using the Bar-Coded Parameter Menu

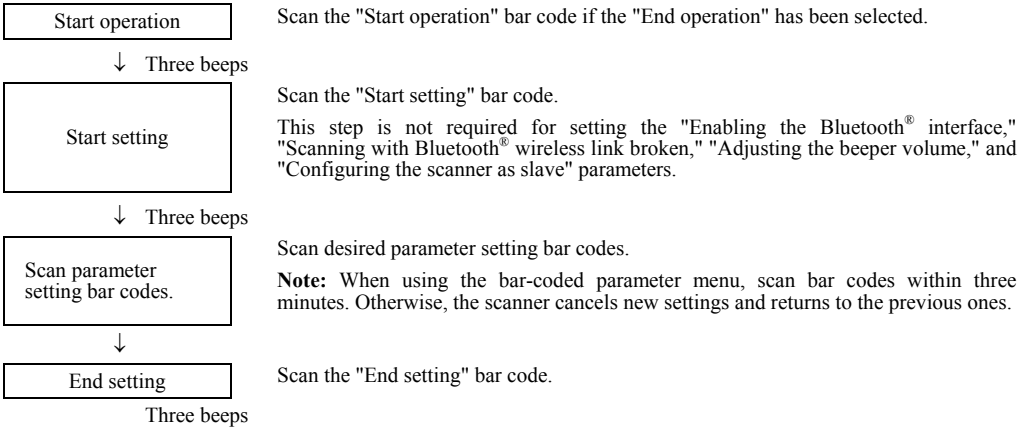

Scanning the "All defaults" bar code in the bar-coded parameter menu makes all items in that menu revert to the factory defaults.

Note: Scan the "Start operation" bar code first before setting any parameter.

Note: It is not necessary to scan the "Start setting" bar code for setting the "Enabling the Bluetooth® interface," "Scanning with Bluetooth® wireless link broken," "Adjusting the beeper volume," and "Configuring the scanner as slave" parameters.

13.2 Bar-Coded Parameter Menu for Scanners

To set parameters given on this page, it is necessary to first scan the "Start operation" bar code, but not necessary to scan the "Start setting" or "End setting" bar code given on the next page.

Enabling the Bluetooth® interface

Scanning the "End operation" bar code can no longer scan bar codes except the "Start operation" bar code. The factory default is "End operation."



Scanning with Bluetooth® wireless link broken

Scanning the "Scan w/ Bluetooth® link broken" bar code allows the scanner to scan bar codes with the Bluetooth® wireless link being broken. With this setting selected, data transfer with the host computer is impossible.

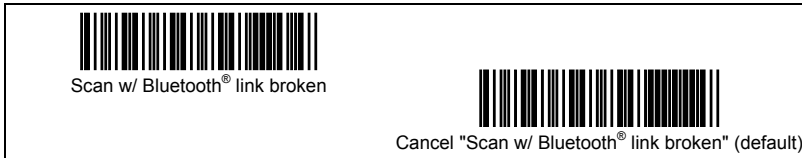

Pairing (device authentication)

Scanning the following bar code allows the scanner to start pairing (device authentication). For the pairing procedure, refer to Appendix 4.



Configuring the scanner as slave

Scanning the following bar code configures the scanner as a slave.



Adjusting the beeper volume

Scanning the following bar code cycles between the High, Medium, and Low settings. The factory default is High.



■ Starting/ending the setting procedure and reverting to defaults

To set parameters given on the following pages, it is necessary to scan the "Start setting" bar code. To complete the setting procedure, scan the "End setting" bar code.



Start setting



End setting



All defaults

■ Bluetooth® interface communications parameters

Communications protocol





Header

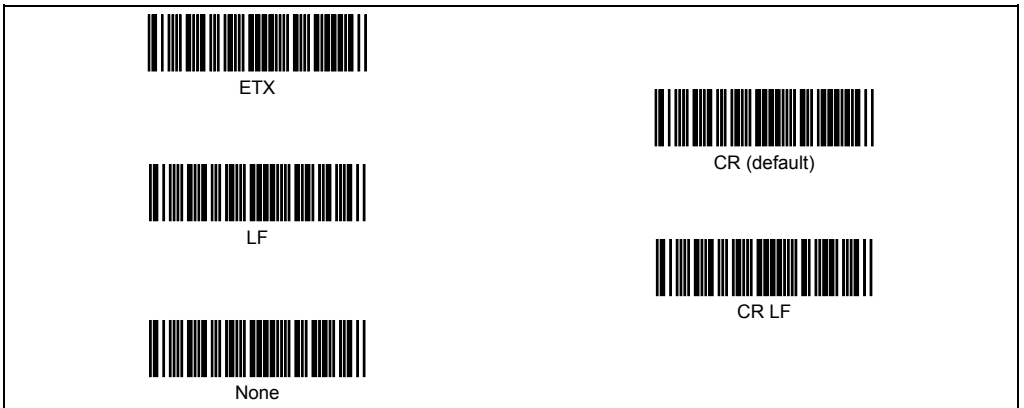

Terminator

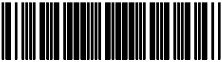

Timeout period for slave to wait for a connection request

 <p>2 minutes (default)</p>	 <p>4 minutes</p>
 <p>10 minutes</p>	 <p>30 minutes</p>

Clearing the transfer buffer when the Bluetooth® wireless link breaks

 <p>Enable</p>	 <p>Disable (default)</p>
---	--

■ Data transmission format and bar code symbologies

Transmission of code ID mark

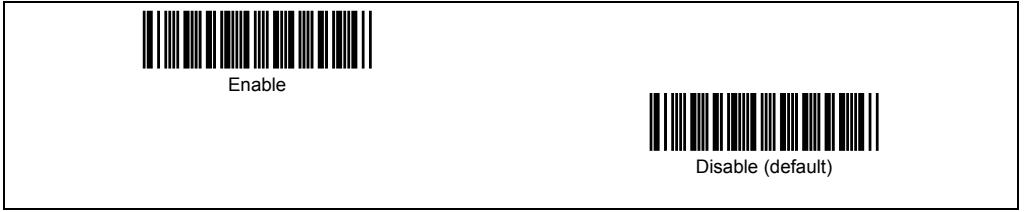

Code ID mark position



Types of code ID mark

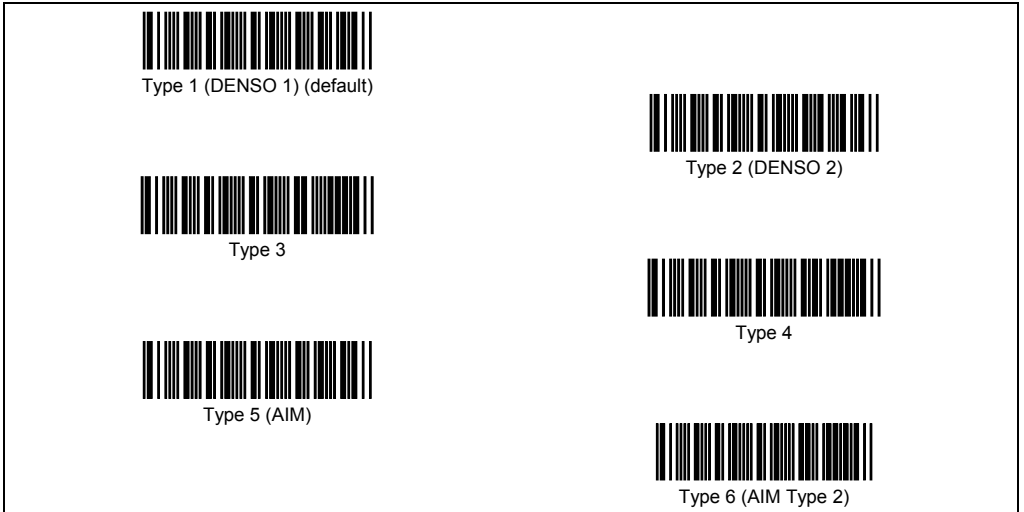

Transmission of the number of digits (not applicable to UPC/EAN codes)

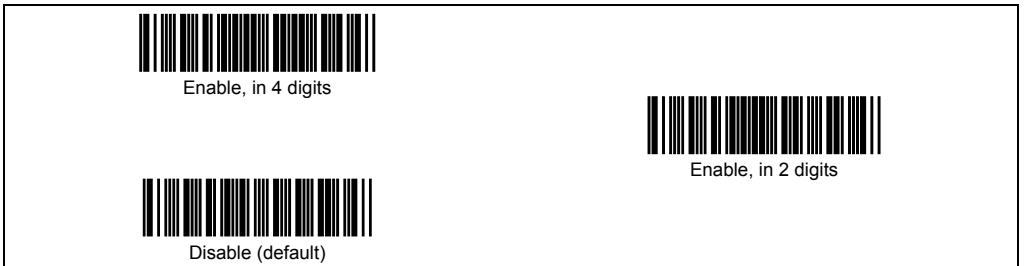

UPC-A/E and EAN-13/8

Scanning UPC-A, UPC-E, EAN-13 and EAN-8

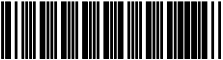
 Enable (default)	 Disable
---	--

Scanning UPC/EAN with Add-on

 Enable, no restriction on add-on digits	 Enable 5-digit add-on only
 Enable 2-digit add-on only	 Disable (default)

Transmission of the number system character of UPC-A

 Enable (default)	 Disable
---	--

Transmission of the number system character of UPC-E

 Enable (default)	 Disable
---	--

Transmission of padding characters "0" for the specified number of digits of UPC-A

 Enable (default)	 Disable
---	--

Transmission of padding characters "0" for the specified number of digits of UPC-E



Transmission of a check digit for UPC-A



Transmission of a check digit for UPC-E



Transmission of a check digit for EAN-13



Transmission of a check digit for EAN-8





Transmission format of EAN-8 (Conversion to EAN-13)

 Enable conversion	 Disable conversion (default)
---	---

Transmission format of UPC-E (Conversion to UPC-A)

 Enable conversion	 Disable conversion (default)
--	---

Transmission of country code for EAN-13

 Enable (default)	 Disable
---	--

Conversion to ISBN/ISSN format for EAN-13

 Enable	 Disable (default)
---	--

Standard 2of5

Scanning Standard 2of5

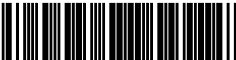
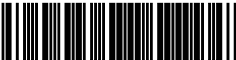
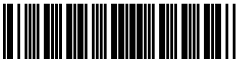
 Enable, without C/D	 Enable, with C/D
 Disable (default)	

Transmission of a check digit for Standard 2of5



Specification of the number of digits for Standard 2of5, by bar code scanning



Interleaved 2of5

Scanning Interleaved 2of5



Transmission of a check digit for Interleaved 2of5





Specification of the number of digits for Interleaved 2of5, by bar code scanning



Codabar (NW-7)

Scanning Codabar (NW-7)

 Enable, without C/D (default)	 Enable, with C/D
 Disable	



Transmission of a check digit for Codabar (NW-7)

 Enable (default)	 Disable
---	--

Check digit method for Codabar (NW-7)

 MOD-16 (default)	 7-check method
---	---

Transmission of start/stop codes for Codabar (NW-7)

 Transmit a/b/c/d	 Transmit A/B/C/D
 Disable (default)	

Code 32

Conversion from Code 39 to Code 32 format



Enable

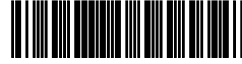

Disable (default)

Transmission of leading "A" in Code 32 data

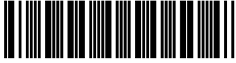

Enable



Disable (default)

Checking of a check digit in Code 32 data





Enable





Disable (default)

Code 39

Scanning Code 39

 Enable, without C/D (default)	 Enable, with C/D
 Disable	

Transmission of a check digit for Code 39

 Enable (default)	 Disable
---	--

Transmission of start/stop codes for Code 39

 Enable	 Disable (default)
---	--

Conversion to Full ASCII for Code 39

 Enable	 Disable (default)
--	--



Code 93

Scanning Code 93

 Enable	 Disable (default)
---	--

Code 128/EAN-128



Scanning Code 128

 Enable (default)	 Disable
---	--

Scanning EAN-128

 Enable (default)	 Disable
---	--

Transmission of FNC1 for Code 128 and EAN-128

 Transmit after conversion to GS (default)	 Disable
--	--

MSI

Scanning MSI

 Enable	 Disable (default)
---	---

Plessey

Scanning Plessey

 Enable	 Disable (default)
---	--

RSS

Scanning RSS-14, RSS-14 Truncated, RSS-14 Stacked, RSS-14 Stacked Omnidirectional



Scanning RSS Limited

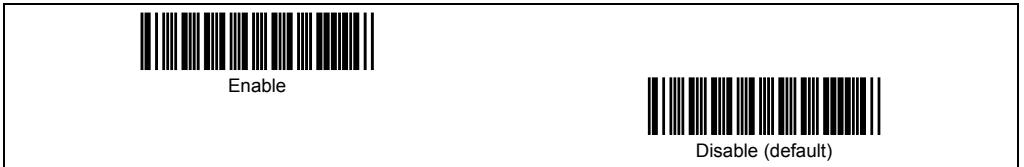

GTIN

GTIN format conversion

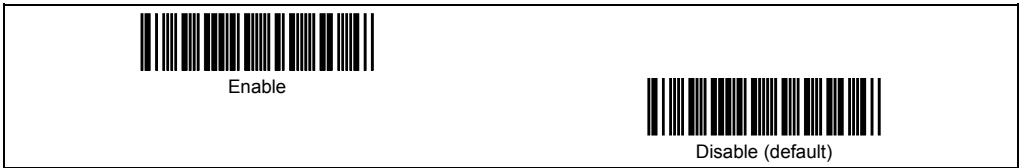

Conversion type from EAN/UPC/Interleaved 2of5 (14-digit) to GTIN format



Conversion type from RSS/EAN-128 in GTIN format to EAN format



■ Trigger switch control and magic key control

Trigger switch control



Auto-off mode 1

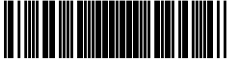

Momentary switching mode 1 (default)

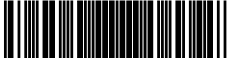

Continuous reading mode

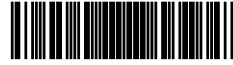

Auto-off mode 2



Momentary switching mode 2

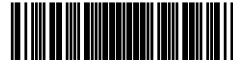

Auto sensing mode

Magic key control



Illumination switching function



Specific character transfer function



Auto sensing mode switching function

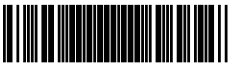

No function (default)

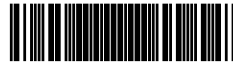

Data retransfer function



Ready/standby switching function



Continuous reading mode switching function

Scanner sensibility level in auto sensing mode

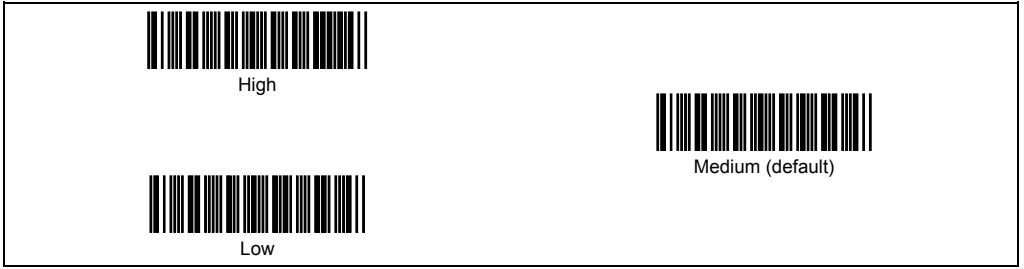

■ Beeper, indicator LED and vibrator

Beeper



Trigger timing for the reading completion beeper and indicator LED



Beeper when reading RSS-14 Stacked and RSS-14 Stacked Omnidirectional



Beeping pattern when reading RSS-14 Stacked and RSS-14 Stacked Omnidirectional



Indicator LED



Enable (default)



Disable

Vibrator



OK vibrations (default)



NG vibrations



Disable

■ Data verification mode

Data verification mode



Regular read mode (default)



Data verification mode

Data verification type



2-point verification



n-point verification (default)

Verification retry after mismatch in 2-point verification

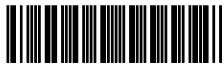





Disable (default)



Enable

Verification result output in data verification mode (Report of match/mismatch status)

 <p>Disable transmission/Disable transmission (default)</p>	 <p>Enable bar code data transmission/Disable transmission</p>
 <p>Enable bar code data transmission/Enable NG transmission</p>	 <p>Enable OK transmission/Enable NG transmission</p>

Verification start position in data verification mode

 <p>1st character (default)</p>	 <p>2nd character</p>
 <p>3rd character</p>	 <p>4th character</p>
 <p>5th character</p>	 <p>6th character</p>
 <p>7th character</p>	



Number of characters to verify, starting from the verification start position

 1 character	 2 characters
 3 characters	 4 characters
 5 characters	 6 characters
 7 characters	 Not specified (default)

Scan lock in data verification read

 Enable	 Disable (default)
---	--

■ Notification of a scanning failure under software control

 Enable CAN (18h) transmission (default)	 Enable "ERROR" transmission
 Disable transmission	

■ Reading with scanner mounted on charger

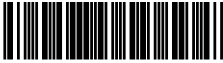

Enable



Disable (default)

14.1 Configuring the Bluetooth® Adapter from the Scanner

The scanner can configure the Bluetooth® adapter by transferring the adapter parameter settings held in the scanner memory via the Bluetooth® wireless link using the following procedure.

Scanner
Store the Bluetooth® adapter parameter settings into the scanner memory.



Bluetooth® adapter
Power the Bluetooth® adapter.



Bluetooth® adapter
Switch to the setup mode.



Scanner
Bluetooth® adapter

Indicator LED: Remains Off
Interface/power supply LED: Flashes orange
Bluetooth® status display LED (blue): Flashes slowly

(The Bluetooth® adapter, as a slave, is waiting for a master to connect.)

Scanner
Establish the Bluetooth® wireless link.



Scanner's indicator LED: Flashes blue
(The scanner beeps three times and initiates a Bluetooth® wireless link, as a master.)

Scanner → Bluetooth® adapter
Transfer the Bluetooth® adapter parameter settings.



Scanner
Bluetooth® adapter

Use the scanner to scan the bar-coded parameter menu prepared for Bluetooth® adapters (Section 14.2) to store their settings into the scanner memory.

Note: Using the configuration software ScannerSetting designed for scanners also allows parameter settings for Bluetooth® adapters. It, however, requires connecting the adapter via a USB-COM or RS-232C interface to the host computer. For details, refer to the "Bluetooth® Adapter User's Manual."

Power the Bluetooth® adapter.

Note: Any type of interfaces that power the Bluetooth® adapter can be used, regardless of the interface setting made in the adapter. For the interfacing procedure, refer to the "Bluetooth® Adapter User's Manual," Chapter 2.

Hold down the SETUP button provided on the bottom of the Bluetooth® adapter for at least 0.5 second with a pin or the like to switch to the setup mode.

Note: Leaving the Bluetooth® adapter for 3 minutes or more after depression of the SETUP button automatically exits the setup mode.

Use the scanner holding Bluetooth® adapter parameter settings to scan the bar code printed on the bottom of the Bluetooth® adapter.

After establishment of the Bluetooth® wireless link, the scanner inquires of the Bluetooth® adapter about the current status and transfers the Bluetooth® adapter parameter settings stored in the memory.

Tip: If the scanner cannot receive an acknowledge response from the Bluetooth® adapter, it cancels the parameter setting sequence. Both the scanner and Bluetooth® adapter automatically return to standby for initiation of the Bluetooth® wireless link.

Indicator LED: Flashes green
Bluetooth® status display LED (blue): Flashes rapidly

End of transfer

After normal end of transfer of parameter settings, the scanner's indicator LED turns blue with one beep.

If the parameter transfer does not end normally, the scanner's indicator LED turns red with three beeps.

Both the scanner and Bluetooth® adapter automatically reset themselves regardless of whether the parameter transfer ends normally.

Bluetooth® adapter Interface/power supply LED: Lights in green
(Both the scanner and Bluetooth® adapter switch to standby for initiation of the Bluetooth® wireless link.)

14.2 Bar-Coded Parameter Menu for Bluetooth® Adapters

■ Starting and ending the setting procedure, and restoring to defaults

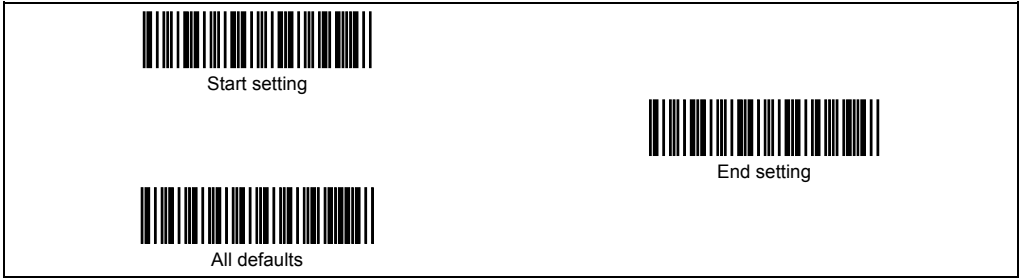

■ Setting the interface



■ Bluetooth® interface communications parameters

Clearing the transfer buffer when the Bluetooth® wireless link breaks



Connection target



Reception of split packets

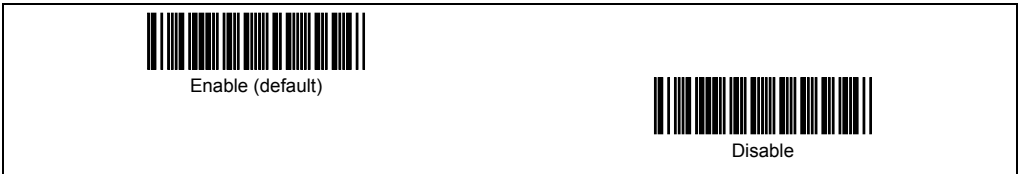

■ USB keyboard interface communications parameters

Caps mode (USB keyboard interface)



Caps Lock of host's keyboard (USB keyboard interface)



Keyboard type (USB keyboard interface)

Select the connected keyboard type.

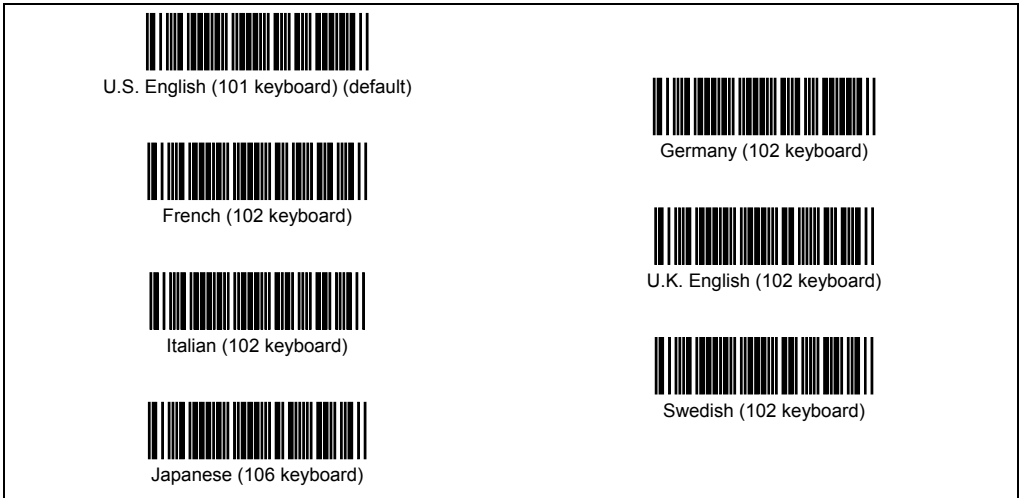

Data transmission interval (USB keyboard interface)

This parameter provides a choice of the following data transmission intervals that apply when the Bluetooth® adapter transfers data read by the scanner to the host computer.

 3 ms (default)	 6 ms
 10 ms	 16 ms
 30 ms	 50 ms
 100 ms	

Numeric key type (USB keyboard interface)

 Inboard numeric keys (default)	 Numeric keypad
---	---

Special key transmission (USB keyboard interface)

 Enable	 Disable (default)
--	--

■ **USB-COM interface communications parameters**

Monitoring CTS (USB-COM interface)



Enable (default)



Disable

■ RS-232C interface communications parameters

Transmission speed (RS-232C interface)

 1200 bps	 2400 bps
 4800 bps	 9600 bps (default)
 14400 bps	 19200 bps
 38400 bps	 57600 bps
 115200 bps	

Data bit (RS-232C interface)

 7 bits	 8 bits (default)
---	---

Parity (RS-232C interface)

 ODD	 EVEN
 None (default)	

Stop bit (RS-232C interface)



1 bit (default)



2 bits

Monitoring CTS (RS-232C interface)



Enable (default)



Disable

■ PS/2 keyboard interface communications parameters

Keyboard connection type (PS/2 keyboard interface)

 With external keyboard (default)	 Without external keyboard
---	--

Caps Lock of host's keyboard (PS/2 keyboard interface)

Select the Caps Lock state that matches the host's keyboard state.

 OFF (default)	 ON
--	---





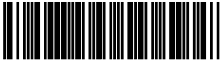

Num Lock mode (PS/2 keyboard interface)

Select the Num Lock state that matches the host's keyboard state.

 ON (default)	 OFF
---	--

Keyboard type (PS/2 keyboard interface)

Select the connected keyboard type.

 U.S. English (101 keyboard) (default)	 Germany (102 keyboard)
 French (102 keyboard)	 U.K. English (102 keyboard)
 Italian (102 keyboard)	 Swedish (102 keyboard)
 Japanese (106 keyboard)	



Data transmission interval (PS/2 keyboard interface)

Select the data transmission interval that matches the computer's processing speed.

Setting a too short interval may cause the computer to fail to display bar code data correctly (e.g., character missing). If it happens, set a longer interval.

 1 ms (default)	 5 ms
 10 ms	 15 ms
 30 ms	 50 ms
 100 ms	

Numeric key type (PS/2 keyboard interface)

 Inboard numeric keys (default)	 Numeric keypad
---	---

Special key transmission (PS/2 keyboard interface)

 Enable	 Disable (default)
--	--

Chapter 15 Troubleshooting

Problem 1: Bar code data not displayed on the computer screen correctly.

Probable cause	What to do:
<ul style="list-style-type: none">• The target Bluetooth® device is not ready for communication.	<ul style="list-style-type: none">• Refer to the user's manual of the target Bluetooth® device.
<ul style="list-style-type: none">• The target Bluetooth® device is located too far from your scanner.	<ul style="list-style-type: none">• Check the Bluetooth® wireless link status for the scanner. If there is no connection, bring the scanner and the Bluetooth® device at the other end closer together until one is established. (See Sections 2.2 and 2.5.)
<ul style="list-style-type: none">• The Bluetooth® wireless link with the target Bluetooth® device is not established.	<ul style="list-style-type: none">• Check the Bluetooth® wireless link status for the scanner. If there is no connection, establish one between the scanner and the Bluetooth® device at the other end. (See Sections 2.2 and 2.5.)
<ul style="list-style-type: none">• The "Scanning w/ Bluetooth® wireless link broken" is selected.	<ul style="list-style-type: none">• Cancel the setting. (See Chapter 3.)

Problem 2: Low reading efficiency.

Probable cause	What to do:
<ul style="list-style-type: none">• A target bar code is not within the scan range of the reading window.	<ul style="list-style-type: none">• Bring a bar code within the scan range. (See Chapter 3.)
<ul style="list-style-type: none">• The bar code may be smeared.	<ul style="list-style-type: none">• Either wipe the dirty bar code or use a clean one.
<ul style="list-style-type: none">• The bar code may be blurred.	<ul style="list-style-type: none">• Use a bar code clearly printed.

Problem 3: Cannot read bar codes.

Probable cause	What to do:
<ul style="list-style-type: none">• There is no connection to the Bluetooth® device at the other end.	<ul style="list-style-type: none">• The scanner cannot read in bar codes until it has established a connection to the Bluetooth® device at the other end. Before any reads, check the Bluetooth® wireless link connection status for the scanner. If there is no connection, establish one before any reads. (See Section 2.5.)
<ul style="list-style-type: none">• The type of the bar code to be scanned has not been set as a readable code.	<ul style="list-style-type: none">• Enable the type of the bar code to be scanned as a readable code. (See Section 13.2.)
<ul style="list-style-type: none">• The bar code read contains no check digit, while the "Enable, with C/D" parameter is selected.	<ul style="list-style-type: none">• Select the "Enable, without C/D" parameter. (See Section 13.2.)
<ul style="list-style-type: none">• The check digit contained in the bar code read is wrong.	<ul style="list-style-type: none">• Use bar codes with correct check digits.

Problem 4: Scanner's operation period too short even after recharge.

Probable cause	What to do:
<ul style="list-style-type: none"> • If fully discharging and then recharging (i.e. refreshing) cannot solve this problem, the service life is expired. (See Section 11.1.) 	<ul style="list-style-type: none"> • Replace the battery cartridge. (See Section 11.2.)
<ul style="list-style-type: none"> • The scanner may not be placed in the charger properly. 	<ul style="list-style-type: none"> • Place the scanner in the charger properly. (See Section 11.1.)

Problem 5: Bluetooth® wireless link unexpectedly broken.

Probable cause	What to do:
<ul style="list-style-type: none"> • The automatic disconnection may be enabled. 	<ul style="list-style-type: none"> • Press the trigger switch to reestablish the Bluetooth® wireless link. • Change the timeout period for scanner to wait for a connection request if necessary. (See Section 10.1.)

Problem 6: The scanner does not read while on the charger.

Probable cause	What to do:
<ul style="list-style-type: none"> • The scanner used does not support reading while mounted on the charger. 	<ul style="list-style-type: none"> • Model numbers 454800-8620 and 454800-8630 do not support reading while mounted on the charger. Remove the scanner from the charger for reads.
<ul style="list-style-type: none"> • The "Reading with scanner mounted on charger" has not been enabled. 	<ul style="list-style-type: none"> • Enable reading on the charger.

Problem 7: Using data packaging (packetizing) produces errors.

Probable cause	What to do:
<ul style="list-style-type: none"> • The scanner and/or Bluetooth® adapter are not correctly configured. 	<ul style="list-style-type: none"> • Using data packaging requires the following communications settings at the two ends: <ul style="list-style-type: none"> - At the scanner: Data packaging mode (to BA10-RKU) - At the Bluetooth® adapter: GT10 series as target (See Section 10.3.)
<ul style="list-style-type: none"> • The host does not return responses to the scanner. 	<ul style="list-style-type: none"> • Using data packaging requires that the target device return an ACK/NAK response to the data from the scanner. Check the host application settings. (See Section 10.3.)

Problem 8: Pairing does not succeed.

Probable cause	What to do:
<ul style="list-style-type: none"> • The PIN code is not correct. 	<ul style="list-style-type: none"> • Specify the correct PIN code.
<ul style="list-style-type: none"> • The Bluetooth® device at the other end is not configured for pairing. 	<ul style="list-style-type: none"> • Refer to the manual for the Bluetooth® device at the other end.
<ul style="list-style-type: none"> • The Bluetooth® device at the other end does not support pairing. 	<ul style="list-style-type: none"> • Refer to the manual for the Bluetooth® device at the other end. No support means no pairing.

Appendix 1 Specifications

Item		GT10B-SB/GT10B-LB
Scanning specifications	Bar code symbologies available	EAN-13, EAN-8, UPC-A, UPC-E, UPC/EAN with add-on, Interleaved 2 of 5, Standard 2 of 5, Code 32, Code 39, Codabar (NW-7), Code 93, Code 128, EAN-128, MSI, Plessey, RSS-14, RSS-14 Truncated, RSS-14 Stacked, RSS-14 Stacked Omnidirectional, RSS Limited (The RSS Expanded and RSS Expanded Stacked symbologies are not supported by this scanner.)
	Scanning direction	Bidirectional
	Scanning resolution	GT10B-SB: 4.9 mils (0.125 mm) GT10B-LB: 7.5 mils (0.19 mm)
	Elevation angle (skew)	±40° (*1)
	Tilt angle (pitch)	±20° (*1)
	Light source	LED set (red)
	Reading confirmation	Indicator LED, beeper, and vibrator
Interface	Bluetooth®	Built-in wireless module compliant with Bluetooth® Specification Ver. 1.1
Power source	Main power	Ni-MH battery cartridge
	Operating voltage	2.4 VDC
Operating time per charge (reference value)		35 hours at Ta = 25°C (*2)
Environmental conditions	Operating temperature range	0 to 50°C
	Operating humidity range	10 to 90% RH (*3)
	Storage temperature range	-10 to 60°C (*3)
	Storage humidity range	5 to 95% RH (*3)
	Ambient illuminance range	Max. 10,000 lux
Dimensions (W) x (D) x (H)		3.2 x 4.1 x 6.5 inches (82 x 103 x 165 mm)
Weight		Approx. 250 g (including a battery cartridge)

(*1) Under these conditions

- EAN-13 and EAN-8 labels conforming to EAN SYMBOL SPECIFICATIONS
- Magnification ratio: 1.0
- Space reflectance: 0.8
- Bar reflectance: 0.1
- Black bars on a white background

(*2) Under these conditions

- Default settings.
- With a new battery cartridge loaded.
- Reading once every 5 seconds
- Vibrator: ON
- Bluetooth® device at the other end: Bluetooth® adapter BA10-RKU
- Holding-down time of trigger switch: 1 sec
- Barcode: ITF 14 digits, Magnification ratio 0.5, PCS = 0.9

(*3) Sharp temperature change, dewing or freezing not allowed, wet-bulb temperature 30°C max.

Reading diagrams GT10B-SB

Speed-priority scanning

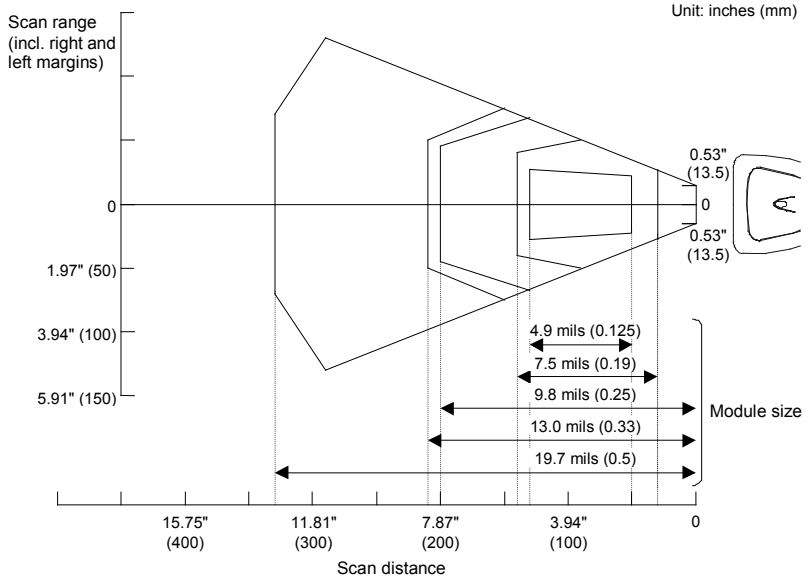

Depth-priority scanning

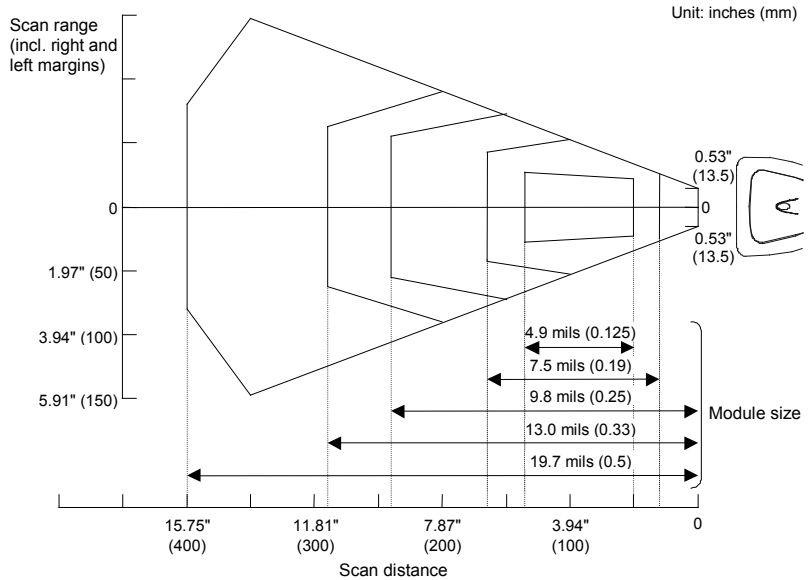

Reading diagrams GT10B-LB

Speed-priority scanning

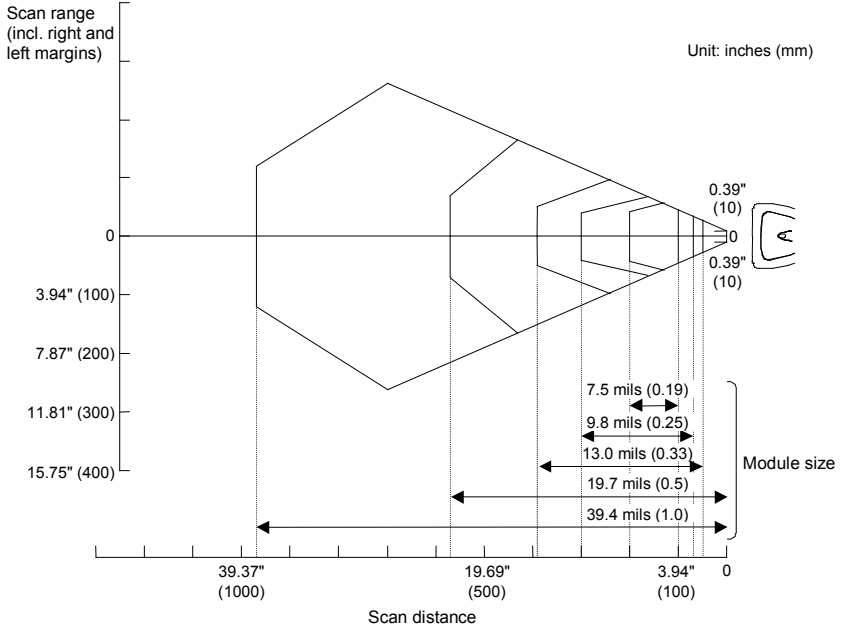

Depth-priority scanning

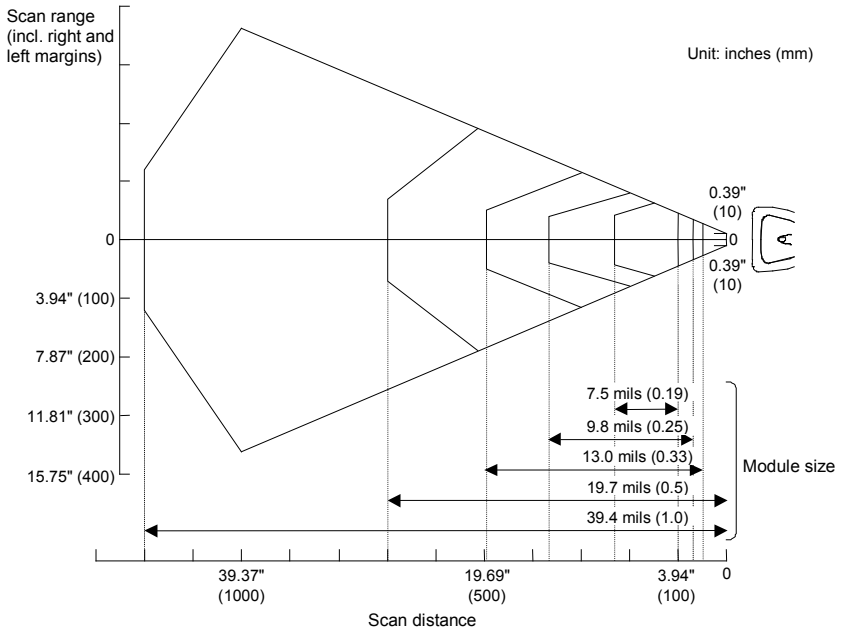

Appendix 2 Bar Code Sample Label



031323120786

UPC-A



4901567014010

EAN-13



0440238 10

UPC-E with 2-digit add-on

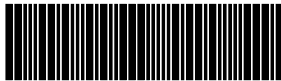

0123457

Standard 2of5



b-\$/0B

Codabar (NW-7)



1G1AZ37

Code 93



4906906

UPC-E



49400397

EAN-8



9780330290951

90000

EAN-13 with 5-digit add-on



0123456784

Interleaved 2of5



TESTE

Code 39



121347
Code 128



11970
EAN-128



1234558
MSI

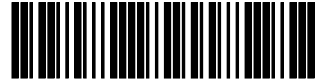

98765C9
Plessey



(01)12345678901231
RSS-14



(01)12345678901231
RSS-14 Stacked



(01)12345678901231
RSS Limited

Appendix 3 Bluetooth® Glossary

The table below lists Bluetooth® terms used in this manual.

Bluetooth® Address (BD_ADDR)	Bluetooth® Device Address. Each Bluetooth® equipment is allocated a unique 48-bit device address defined by the Bluetooth® SIG.
Bluetooth® Passkey (PIN)	Bluetooth® Personal Identification Number. This is a maximum of 16 bytes of passkey used to authenticate two Bluetooth® devices in pairing. Once authentication is performed, no Bluetooth® passkey input is required for the next authentication.
Local Name	Bluetooth® Device Name. This is a user-friendly name for the Bluetooth® Device to identify itself.
Bluetooth® Wireless Link	Wireless communications line connecting the master and slave devices.
Master	Master device that initiates and requests operations and controls slave devices.
Slave	Slave device that is network-controlled by the master device in Bluetooth® wireless communication.

Appendix 4 Pairing (Device authentication)

Pairing (or bonding) is the Bluetooth® authentication process for confirming the device at the other end and thus blocking indiscriminate access from just any Bluetooth® device. It involves mutual authentication between two Bluetooth® devices by exchanging a mutually agreed PIN code (or pass key) when they first connect. This approach allows the two devices to both establish a secure link and rapidly access device services without re-entering the PIN code for subsequent connections.

The timeout interval for scanner pairing is 2 minutes 30 seconds. Failure to complete pairing within this interval shifts the scanner to its standby state. Success shifts it to its connection standby state.

The scanner supports PIN codes 0 to 8 bytes long consisting of letters, digits, and certain other ASCII characters.

Changing scanner PIN code

The scanner ships with an initial PIN code of 1234. Use the scanner configuration software (ScannerSetting) to change this.

Initiating pairing from the scanner

The following is the procedure for initiating pairing with the target Bluetooth® device from the scanner.

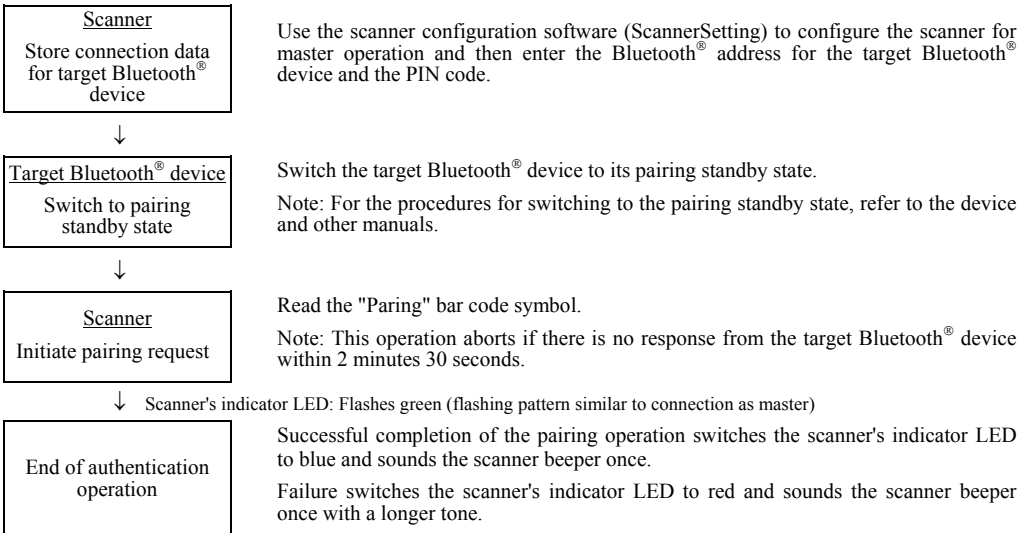

The scanner waits in its connection standby state for a Bluetooth® wireless link.

Scanner response to pairing requests

The following is the procedure for responding to a pairing request from a Bluetooth® device to the scanner.

Scanner
Store PIN code.



Scanner
Wait for pairing request

Use the scanner configuration software (ScannerSetting) to configure the scanner for slave operation and then enter the PIN code.

Read the "Pairing" bar code symbol.

Note: This operation aborts if there is no pairing request from the target Bluetooth® device within 2 minutes 30 seconds.



Scanner's indicator LED: Flashes green (flashing pattern similar to connection as slave)

Target Bluetooth® device
Start pairing sequence

Select the scanner for pairing from the list of target Bluetooth® devices and enter the PIN code.

Note: For further details on the procedures, refer to the device and other manuals.



End of authentication
operation

Successful completion of the pairing operation switches the scanner's indicator LED to blue and sounds the scanner beeper once.

Failure switches the scanner's indicator LED to red and produces a longer beeper tone.

The scanner waits in its connection standby state for a Bluetooth® wireless link.

Appendix 5 Quick Setup for the Use of USB Keyboard Interface

■ Requirements

Hardware

- USB-equipped computer
- Scanner GT10B-SB or GT10B-LB
- Bluetooth® adapter BA10-RKU
- USB interface cable for Bluetooth® adapters

Software

- USB-COM port driver*
- Configuration software (BASetting)* for Bluetooth® adapters

Manuals

- Bar Code Handy Scanner User's Manual (this book)*
- Bluetooth® Adapter User's Manual*

*These software and manuals are available as free downloads from our website "QBdirect" at <http://www.qbdirect.net>. Before downloading, you are requested to register as a member (free of charge).

■ Changing Bluetooth® adapter's interface to USB keyboard interface

The following is the procedure for changing the Bluetooth® adapter's interface to the USB keyboard interface (default). If it is not changed from the default, you need to specify the keyboard type matching the usage environment. An incorrect setting sometimes garbles characters.

- (1) Download the configuration software (BASetting) from our website (QBdirect) and install it on the computer.
- (2) Connect the Bluetooth® adapter to a USB port on the computer using the USB interface cable provided.

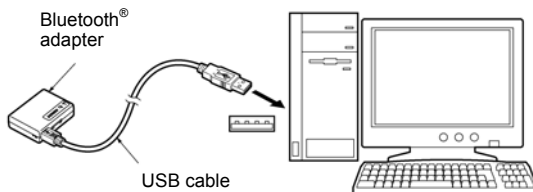

- (3) Press the SETUP button on the rear of the Bluetooth® adapter for at least 0.5 second to switch it to Setup mode.

SETUP button



Bluetooth® adapter (rear)

The interface/power supply LED flashes orange, indicating that the Bluetooth® adapter has switched to Setup mode.

- (4) Wait for the Found New Hardware wizard (Windows XP/Windows 2000)* to automatically start on the computer. Following the wizard's on-screen instructions, install the USB-COM port driver.

*New Hardware Found wizard (Windows Me) or Add New Hardware Wizard (Windows 98/98SE)

For further details on installing the USB-COM port driver, refer to the Bluetooth® Adapter user's manual.

- (5) Check the port number for the driver just installed with the Windows Device Manager, under Ports.

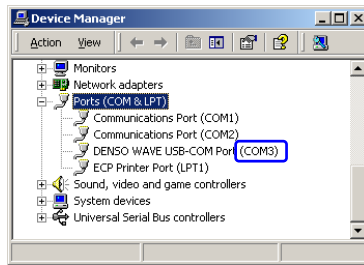

- (6) Start the configuration software (BASetting) on the computer. Press the OK button when the following screen appears.

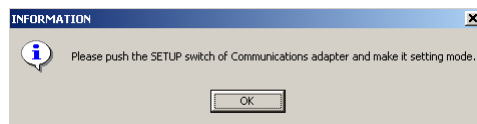

- (7) When the following screen appears, specify the port number for the USB-COM port driver installed.

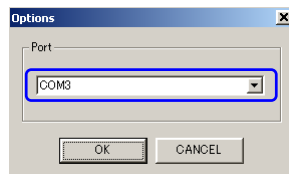

- (8) Check that the USB keyboard is selected and then specify the keyboard type matching the usage environment.

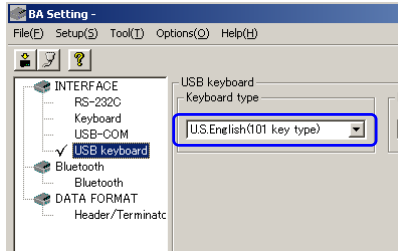

- (9) On the file menu, choose Apply new settings to switch the Bluetooth® adapter's USB keyboard to the specified type.

■ Establishing a Bluetooth® wireless link between the scanner and the Bluetooth® adapter

- (1) Use the scanner to read the bar code printed on the back of the target Bluetooth® adapter.

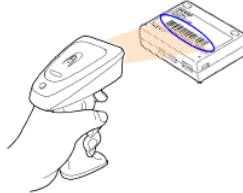

Reading in the Bluetooth® adapter's bar code configures the scanner as a master and initiates connection to the Bluetooth® adapter.

- (2) Successful connection sounds the scanner beeper twice and switches the scanner's indicator LED to green for 0.5 second. The blue Bluetooth® status display LED on the Bluetooth® adapter also lights.

■ Displaying data from scanner on computer

Open Notepad.exe or other appropriate Windows application program and read bar codes with the scanner. Setup is complete if the data displays normally in the application program.

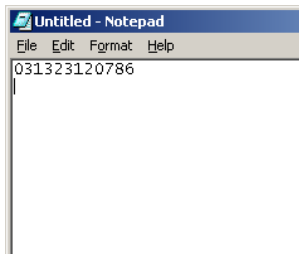

Appendix 6 Quick Setup for the Use of USB-COM Interface

■ Requirements

Hardware

USB-equipped computer
Scanner GT10B-SB or GT10B-LB
Bluetooth® adapter BA10-RKU
USB interface cable for Bluetooth® adapters

Software

USB-COM port driver*
Configuration software (BASetting)* for Bluetooth® adapters

Manuals

Bar Code Handy Scanner User's Manual (this book)*
Bluetooth® Adapter User's Manual*

*These software and manuals are available as free downloads from our website "QBdirect" at <http://www.qbdirect.net>. Before downloading, you are requested to register as a member (free of charge).

■ Changing Bluetooth® adapter's interface to USB-COM interface

The default interface of the Bluetooth® adapter is USB keyboard interface. Change it to USB-COM interface using the following procedure.

- (1) Download the configuration software (BASetting) from our website (QBdirect) and install it on the computer.
- (2) Connect the Bluetooth® adapter to a USB port on the computer using the USB interface cable provided.

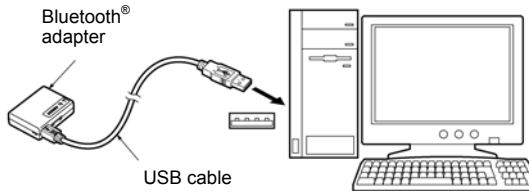

- (3) Press the SETUP button on the rear of the Bluetooth® adapter for at least 0.5 second to switch it to Setup mode.

SETUP button



Bluetooth® adapter (rear)

The interface/power supply LED flashes orange, indicating that the Bluetooth® adapter has switched to Setup mode.

- (4) Wait for the Found New Hardware wizard (Windows XP/Windows 2000)* to automatically start on the computer. Following the wizard's on-screen instructions, install the USB-COM port driver.

*New Hardware Found wizard (Windows Me) or Add New Hardware Wizard (Windows 98/98SE)

For further details on installing the USB-COM port driver, refer to the Bluetooth® Adapter user's manual.

- (5) Check the port number for the driver just installed with the Windows Device Manager, under Ports.

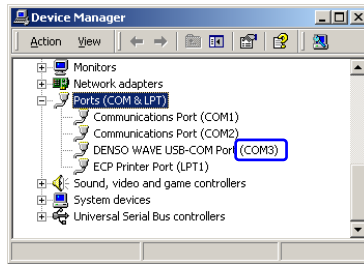

- (6) Load the configuration software (BASetting) on the computer. Press the OK button when the following screen appears.

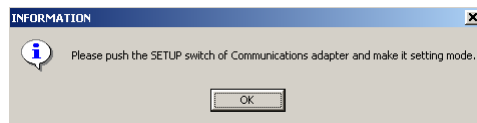

- (7) When the following screen appears, specify the port number for the USB-COM port driver installed.

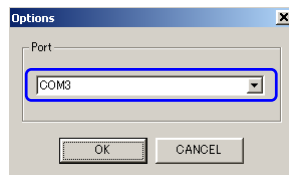

- (8) Specify the USB-COM as interface.

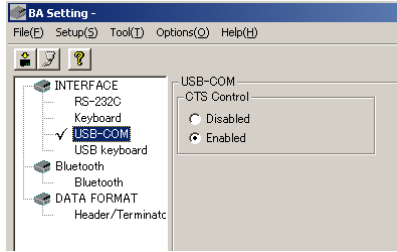

- (9) On the file menu, choose Apply new settings to switch the Bluetooth® adapter's interface to the USB-COM interface.

■ Establishing a Bluetooth® wireless link between the scanner and the Bluetooth® adapter

- (1) Use the scanner to read the bar code printed on the back of the target Bluetooth® adapter.

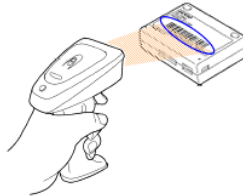

Reading in the Bluetooth® adapter's bar code configures the scanner as a master and initiates connection to the Bluetooth® adapter.

- (2) Successful connection sounds the scanner beeper twice and switches the scanner's indicator LED to green for 0.5 second. The blue Bluetooth® status display LED on the Bluetooth® adapter also lights.

■ Displaying data from scanner on computer

The following is the procedure for displaying data from the USB-COM interface on the computer screen.

- (1) Start HyperTerminal.

Choose the program icon from the Start menu: Start|Programs|Accessories|Communications|HyperTerminal (Start|All programs|Accessories|Communications|HyperTerminal for Windows XP).

- (2) Create new connection.

On the Connection Settings screen, create a new connection.

Name: Enter an easy to understand name. Our example uses GT10.

Icon: Select the icon used when saving the connection settings from the list below and press the OK button.

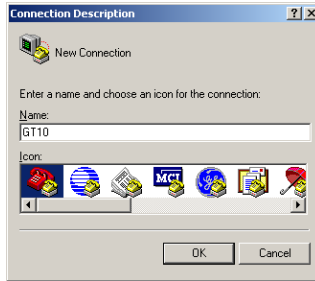

- (3) Specify the connection configuration.

Click the downward facing arrow to the right of the label "Connection configuration," select the port number connected to the Bluetooth® adapter, and press the OK button.

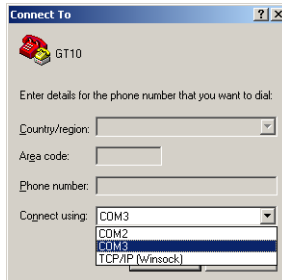

(4) Specify COM port.

The USB-COM driver does not need this setting, so simply press the OK button. This completes HyperTerminal setup.

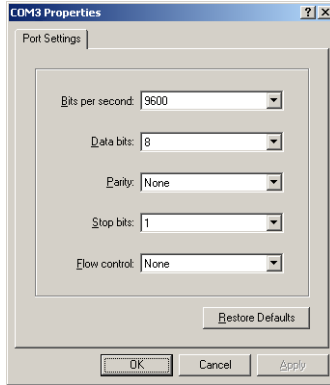

(5) Read a bar code with the scanner. Setup is complete if the data displays normally.

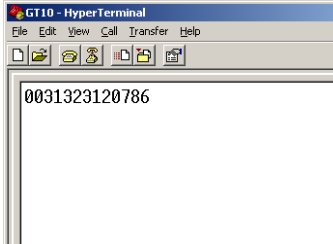

* As an alternative to HyperTerminal, the Denso keyboard interface (QR_kbif) software allows the display of data from the scanner on the computer screen for any program accepting keyboard input. It is available as a free download from our website "QBdirect" at <http://www.qbdirect.net>. Before downloading, you are requested to register as a member (free of charge).

Appendix 7 Quick Setup for the Use of RS-232C Interface

■ Requirements

Hardware

Computer supporting COM ports
Scanner GT10B-SB or GT10B-LB
Bluetooth® adapter BA10-RKU
RS-232C interface cable for Bluetooth® adapters
AC adapter

Software

Configuration software (BASetting)* for Bluetooth® adapters

Manuals

Bar Code Handy Scanner User's Manual (this book)*
Bluetooth® Adapter User's Manual*

*These software and manuals are available as free downloads from our website "QBdirect" at <http://www.qbdirect.net>. Before downloading, you are requested to register as a member (free of charge).

■ Changing Bluetooth® adapter's interface to RS-232C interface

The default interface of the Bluetooth® adapter is USB keyboard interface. Change it to RS-232C interface using the following procedure.

- (1) Download the configuration software (BASetting) from our website (QBdirect) and install it on the computer.
- (2) Connect the Bluetooth® adapter to a COM port on the computer using the RS-232C interface cable provided.

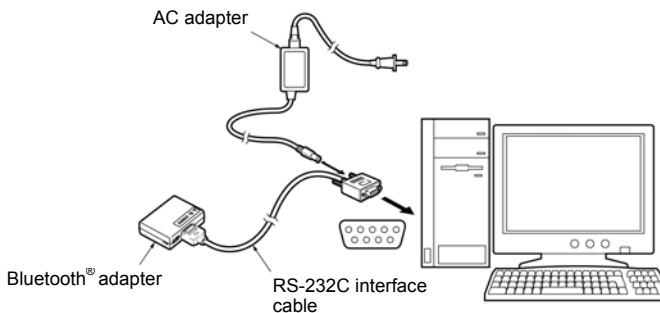

Note: When using the charger built-in type of the RS-232C interface cable, refer to the Bluetooth® Adapter user's manual.

- (3) Press the SETUP button on the rear of the Bluetooth® adapter for at least 0.5 second to switch it to Setup mode.

SETUP button



Bluetooth® adapter (rear)

The interface/power supply LED flashes orange, indicating that the Bluetooth® adapter has switched to Setup mode.

- (4) Start the configuration software (BASetting) on the computer. Press the OK button when the following screen appears.

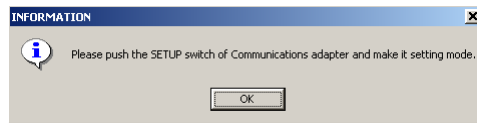

- (5) When the following screen appears, specify the port number connected to the Bluetooth® adapter.

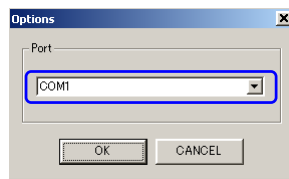

- (6) Select the RS-232C as interface and then specify the transmission speed and others.

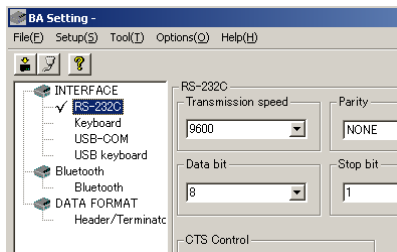

- (7) On the file menu, choose Apply new settings to switch the Bluetooth® adapter's interface to the RS-232C interface.

■ Establishing a Bluetooth® wireless link between the scanner and the Bluetooth® adapter

- (1) Use the scanner to read the bar code printed on the back of the target Bluetooth® adapter.

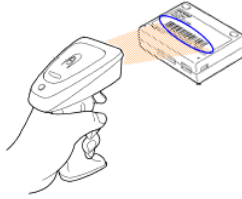

Reading in the Bluetooth® adapter's bar code configures the scanner as a master and initiates connection to the Bluetooth® adapter.

- (2) Successful connection sounds the scanner beeper twice and switches the scanner's indicator LED to green for 0.5 second. The blue Bluetooth® status display LED on the Bluetooth® adapter also lights.

■ Displaying data from scanner on computer

The following is the procedure for displaying data from the RS-232C interface on the computer screen.

- (1) Start HyperTerminal.

Choose the program icon from the Start menu: Start|Programs|Accessories|Communications|HyperTerminal (Start|All programs|Accessories|Communications|HyperTerminal for Windows XP).

- (2) Create new connection.

On the Connection Settings screen, create a new connection.

Name: Enter an easy to understand name. Our example uses GT10.

Icon: Select the icon used when saving the connection settings from the list below and press the OK button.

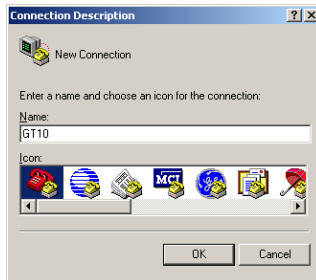

(3) Specify the connection configuration.

Click the downward facing arrow to the right of the label "Connection configuration," select the port number connected to the Bluetooth® adapter, and press the OK button.



(4) Specify COM port.

Specify the COM port parameters that match the Bluetooth® adapter's ones, then press the OK button.

This completes HyperTerminal setup.

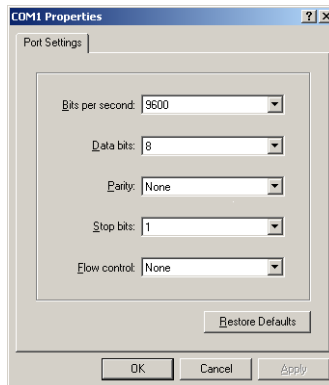

(5) Read a bar code with the scanner. Setup is complete if the data displays normally.

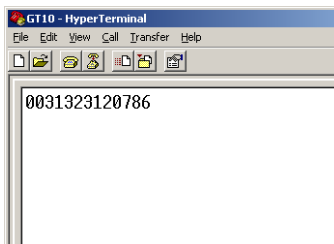

* As an alternative to HyperTerminal, the Denso keyboard interface (QR_kbif) software allows the display of data from the scanner on the computer screen for any program accepting keyboard input. It is available as a free download from our website "QBdirect" at <http://www.qbdirect.net>. Before downloading, you are requested to register as a member (free of charge).

Appendix 8 Quick Setup for the Use of PS/2 Keyboard Interface

■ Requirements

Hardware

USB-equipped computer or computer supporting COM ports

Scanner GT10B-SB or GT10B-LB

Bluetooth® adapter BA10-RKU

PS/2 keyboard interface cable for Bluetooth® adapters

- For using a USB port*

USB interface cable for Bluetooth® adapters

- For using a COM port*

RS-232C interface cable for Bluetooth® adapters

AC adapter

Software

Configuration software (BASetting)* for Bluetooth® adapters

- For using a USB port

USB-COM port driver*

Manuals

Bar Code Handy Scanner User's Manual (this book)*

Bluetooth® Adapter User's Manual*

*These software and manuals are available as free downloads from our website "QBdirect" at <http://www.qbdirect.net>. Before downloading, you are requested to register as a member (free of charge).

<p>* Setting up the Bluetooth® adapter using the configuration software (BASetting) requires connecting the Bluetooth® adapter to the host computer with USB-COM or RS-232C interface.</p>
--

■ Changing Bluetooth® adapter's interface to PS/2 keyboard interface

The default interface of the Bluetooth® adapter is USB keyboard interface. Change the interface to PS/2 keyboard using the following procedure.

- (1) Download the configuration software (BASetting) from our website (QBdirect) and install it on the computer.
- (2) Connect the Bluetooth® adapter to the computer using the USB or RS-232C interface cable provided, and then start the configuration software (BASetting).

For the configuration software setup procedure, refer to the instructions given in Quick Setup for the use of USB-COM or RS-232C interface.

- (3) Select Keyboard as interface and then specify the keyboard type and others. An incorrect setting garbles some characters.



- (4) On the file menu, choose Apply new settings to switch the Bluetooth® adapter's interface to the PS/2 keyboard interface, and the keyboard type to the specified type.
- (5) Replace the current interface cable of the Bluetooth® adapter with a PS/2 keyboard interface cable, then connect the other end of the cable to the keyboard port on the computer.

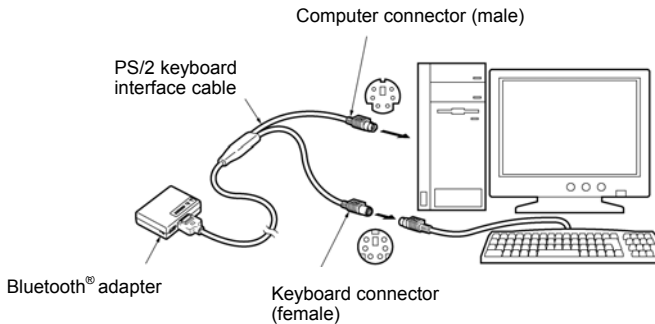

Note: When no external keyboard is used, e.g., on a notebook PC, select "Without external keyboard" for the keyboard connection type using the configuration software (BASetting). In this case, there is no problem leaving the keyboard connector (female) of the PS/2 keyboard interface cable disconnected.

■ Establish a Bluetooth® wireless link between the scanner and the Bluetooth® adapter

- (1) Use the scanner to read the bar code printed on the back of the target Bluetooth® adapter.

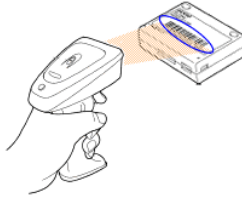

Reading in the Bluetooth® adapter's bar code configures the scanner as a master and initiates connection to the Bluetooth® adapter.

- (2) Successful connection sounds the scanner beeper twice and switches the scanner's indicator LED to green for 0.5 second. The blue Bluetooth® status display LED on the Bluetooth® adapter also lights.

■ Displaying data from scanner on computer

Open Notepad.exe or other appropriate Windows application program and read bar codes with the scanner. Setup is complete if the data displays normally in the application program.

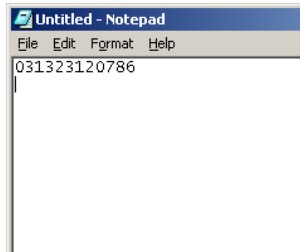

Bar Code Handy Scanner

GT10B-SB
GT10B-LB

User's Manual

First Edition, October 2004
Fourth Edition, September 2008

DENSO WAVE INCORPORATED

DENSO WAVE INCORPORATED

4-2-12, Toranomom, Minato-ku, Tokyo, Japan 105-0001

<http://www.denso-wave.com/>