



**Kyman™**



**User's Manual**



Datalogic Mobile S.r.l.  
Via S. Vitalino, 13  
40012 - Lippo di Calderara di Reno  
Bologna - Italy

Kyman™ - User's Manual

Software Version: 3.03

Ed.: 07/2010

© 2006-2010 Datalogic Mobile S.r.l. • ALL RIGHTS RESERVED. • Protected to the fullest extent under U.S. and international laws. • Copying, or altering of this document is prohibited without express written consent from Datalogic Mobile S.r.l.

Datalogic and the Datalogic logo are registered trademarks of Datalogic S.p.A. in many countries, including the U.S.A. and the E.U.  
KYMAN is a trademark of Datalogic Mobile S.r.l.

All other brand and product names mentioned herein are for identification purposes only and may be trademarks or registered trademarks of their respective owners.  
Datalogic reserves the right to make modifications and improvements without prior notification.

Datalogic shall not be liable for technical or editorial errors or omissions contained herein, nor for incidental or consequential damages resulting from the use of this material.

# CONTENTS

---

<b>REFERENCES .....</b>	<b>V</b>
Conventions .....	v
Reference Documentation .....	v
Services and Support .....	v
<b>SAFETY REGULATIONS .....</b>	<b>VI</b>
General Safety Rules .....	vi
Bluetooth® Approval .....	vi
Laser Safety .....	vii
Radio Compliance .....	xiii
FCC Compliance .....	xv
SAR Compliance .....	xv
Industry Canada Compliance .....	xv
Patents .....	xvi
WEEE Compliance .....	xvii
<b>GENERAL VIEW .....</b>	<b>XIX</b>
<b>1 INTRODUCTION .....</b>	<b>1</b>
1.1 Kyman™ Description .....	1
1.2 Available Models .....	2
1.3 Package Contents .....	2
1.3.1 Using the Belt Clip .....	4
1.4 Handle Mounting .....	6
1.5 Installing the SIM/SD Card .....	7
1.5.1 Removing the SIM Card and SD-Card .....	9
1.6 Accessories .....	10
1.7 Operating System .....	11
<b>2 CONNECTIONS .....</b>	<b>12</b>
2.1 RS232/USB Direct Connection .....	12
2.2 WLAN Connection .....	13
2.3 WPAN Connections .....	15
2.4 WWAN Connections .....	16
2.5 Cradle Connections .....	17
2.6 Connection Cables .....	18
2.7 Wireless and Radio Frequencies Warnings .....	20
<b>3 USE AND FUNCTIONING .....</b>	<b>22</b>
3.1 Startup .....	22
3.2 Windows Mobile Welcome Wizard .....	24
3.3 Using the Stylus .....	25
3.4 Data Capture .....	26
3.4.1 Laser Data Capture .....	26

3.4.2	Imager Data Capture .....	27
3.4.3	RFID Data Capture .....	28
3.5	Description of the Keys .....	29
3.5.1	Alphanumeric Keyboard (53-key Model) .....	29
3.5.2	Numeric Keyboard (36-key Model) .....	32
3.5.3	Resetting the Kyman™ .....	35
3.6	Status Indicators .....	38
3.6.1	LED Status .....	38
3.6.2	Taskbar .....	39
3.7	Data Capture Configuration .....	41
3.7.1	Configure .....	41
3.7.2	Capture .....	47
3.8	Control Panel .....	48
3.8.1	Buttons .....	49
3.8.2	Registry .....	50
3.8.3	Files Admin .....	51
3.8.4	Wireless Communications .....	53
3.8.5	Ethernet Settings .....	55
3.8.6	Stylus Calibration .....	58
3.8.7	Volume Settings .....	62
3.9	Windows Connections .....	66
3.9.1	Microsoft® ActiveSync® .....	66
3.9.2	Bluetooth® Manager Device Setup .....	68
3.9.3	FTP Server Setup .....	75
3.10	Backup Directory File Management .....	76
3.11	Firmware Update for Windows CE .....	77
<b>4</b>	<b>MAINTENANCE .....</b>	<b>78</b>
4.1	Charging the Battery Pack .....	78
4.2	Replacing the Battery Pack .....	80
4.3	Cleaning the Mobile Computer .....	83
<b>5</b>	<b>TECHNICAL FEATURES .....</b>	<b>84</b>
5.1	Technical Data .....	84
5.2	Reading Diagrams .....	88
<b>6</b>	<b>TEST CODES .....</b>	<b>90</b>
	<b>GLOSSARY .....</b>	<b>93</b>
	<b>INDEX .....</b>	<b>96</b>

# REFERENCES

---

## CONVENTIONS

This manual uses the following conventions:

“User” refers to anyone using a Kyman™ mobile computer.

“Mobile computer” and “Kyman™” refer to Kyman™ mobile computer.

“You” refers to the System Administrator or Technical Support person using this manual to install, configure, operate, maintain or troubleshoot a Kyman™ mobile computer.

## REFERENCE DOCUMENTATION

For further information regarding Kyman™ refer to the SDK Help on-Line.

## SERVICES AND SUPPORT

Datalogic provides several services as well as technical support through its website. Log on to **[www.mobile.datalogic.com](http://www.mobile.datalogic.com)** and click on the links indicated for further information including:

- **PRODUCTS**

Search through the links to arrive at your product page where you can download specific **Manuals** and **Software & Utilities**

- **SERVICES & SUPPORT**

- **Datalogic Services** Warranty Extensions and Maintenance Agreements

- **Authorised Repair Centres**

- **CONTACT US**

E-mail form and listing of Datalogic Subsidiaries

# SAFETY REGULATIONS

---



## NOTE

*Read this manual carefully before performing any type of connection to the Kyman™ mobile computer.  
The user is responsible for any damages caused by incorrect use of the equipment or by inobservance of the indication supplied in this manual.*

## GENERAL SAFETY RULES

- Use only the components supplied by the manufacturer for the specific Kyman™ being used.
- Do not attempt to disassemble the Kyman™ mobile computer, as it does not contain parts that can be repaired by the user. Any tampering will invalidate the warranty.
- When replacing the battery pack or at the end of the operative life of the Kyman™ mobile computer, disposal must be performed in compliance with the laws in force.
- Before using the device and the battery packs, read par. 4.2.
- Do not submerge the Kyman™ in liquid products.
- Avoid significant and rapid temperature variations, which can produce condensation inside the Kyman™ and reduce its performance.
- For further information, refer to this manual and to the Datalogic Mobile web site: [www.mobile.datalogic.com](http://www.mobile.datalogic.com).

## BLUETOOTH® APPROVAL

This product is equipped with the following certified Bluetooth® module:

Product Name: Datalogic controller subsystem based on LBMALCS2 MURATA module for Windows CE and Windows Mobile for portable barcode readers application

Bluetooth ID: B016407

Product ID: DLBTLCS2

# LASER SAFETY

The laser light is visible to the human eye and is emitted from the window indicated in the figure.

This information applies to both laser models and the Kyman™ Imager Aiming System.

Laser output window

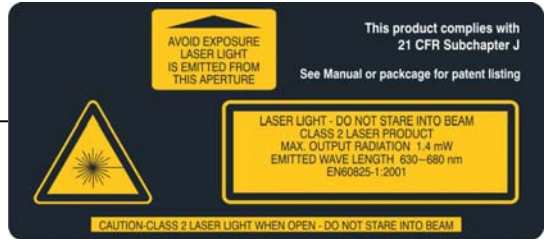

I	D	F	E
La luce laser è visibile all'occhio umano e viene emessa dalla finestra indicata nella figura.	Die Laserstrahlung ist für das menschliche Auge sichtbar und wird am Strahlaustrittsfenster ausgesendet (siehe Bild).	Le rayon laser est visible à l'oeil nu et il est émis par la fenêtre désignée sur l'illustration dans la figure.	La luz láser es visible al ojo humano y es emitida por la ventana indicada en la figura.
LUCE LASER NON FISSARE IL FASCIO APPARECCHIO LASER DI CLASSE 2 MASSIMA POTENZA DI USCITA: 1,4 mW LUNGHEZZA D'ONDA EMESSA: 630-680 nm CONFORME A EN 60825-1 (2001)	LASERSTRAHLUNG NICHT IN DER STRAHL BLINKEN PRODUKT DER LASERKLASSE 2 MAXIMALE AUSGANGLEISTUNG: 1,4 mW WELLENLÄNGE: 630-680 nm ENTSPR. EN 60825-1 (2001)	RAYON LASER EVITER DE REGARDER LE RAYON APPAREIL LASER DE CLASSE 2 PUISSANCE DE SORTIE: 1,4 mW LONGUER D'ONDE EMISE: 630-680 nm CONFORME A EN 60825-1 (2001)	RAYO LÁSER NO MIRAR FIJO EL RAYO APARATO LÁSER DE CLASE 2 MÁXIMA POTENCIA DE SALIDA: 1,4 mW LONGITUD DE ONDA EMITIDA: 630-680 nm CONFORME A EN 60825-1 (2001)

## ENGLISH

The following information is provided to comply with the rules imposed by international authorities and refers to the correct use of your mobile computer.

### STANDARD LASER SAFETY REGULATIONS

This product conforms to the applicable requirements of both CDRH 21 CFR 1040 Subchapter J and EN 60825-1:2001 at the date of manufacture.

For installation, use and maintenance, it is not necessary to open the device.



**CAUTION**

*Do not attempt to open or otherwise service any components in the optics cavity. Opening or servicing any part of the optics cavity by unauthorized personnel may violate laser safety regulations. The optics system is a factory only repair item.*



**CAUTION**

*Use of controls or adjustments or performance of procedures other than those specified herein may result in exposure to hazardous visible laser light.*

The product utilizes a low-power laser diode. Although staring directly at the laser beam momentarily causes no known biological damage, avoid staring at the beam as one would with any very strong light source, such as the sun. Avoid that the laser beam hits the eye of an observer, even through reflective surfaces such as mirrors, etc.



**CAUTION**

*Use of optical systems with the scanner will increase eye hazard. Optical instruments include binoculars, microscopes, eye glasses and magnifying glasses.*

## ITALIANO

Le seguenti informazioni vengono fornite dietro direttive delle autorità internazionali e si riferiscono all'uso corretto del terminale.

### NORMATIVE STANDARD PER LA SICUREZZA LASER

Questo prodotto risulta conforme alle normative vigenti sulla sicurezza laser alla data di produzione: CDRH 21 CFR 1040 sezione J e EN 60825-1:2001.

Non si rende mai necessario aprire l'apparecchio per motivi di installazione, utilizzo o manutenzione.





**ATTENZIONE**

*Non tentare di accedere allo scomparto contenete i componenti ottici o di farne la manutenzione.*

*L'apertura dello scomparto, o la manutenzione di qualsiasi parte ottica da parte di personale non autorizzato, potrebbe violare le norme della sicurezza. Il sistema ottico può essere riparato solamente alla fabbrica.*



**ATTENZIONE**

*L'utilizzo di procedure o regolazioni differenti da quelle descritte nella documentazione può provocare un'esposizione pericolosa a luce laser visibile.*

Il prodotto utilizza un diodo laser a bassa potenza. Sebbene non siano noti danni riportati dall'occhio umano in seguito ad una esposizione di breve durata, evitare di fissare il raggio laser così come si eviterebbe qualsiasi altra sorgente di luminosità intensa, ad esempio il sole. Evitare inoltre di dirigere il raggio laser negli occhi di un osservatore, anche attraverso superfici riflettenti come gli specchi.



**ATTENZIONE**

*L'uso di strumenti ottici assieme allo scanner può aumentare il pericolo di danno agli occhi. Tali strumenti ottici includono cannocchiali, microscopi, occhiali e lenti di ingrandimento.*

## DEUTSCH

Die folgenden Informationen stimmen mit den Sicherheitshinweisen überein, die von internationalen Behörden auferlegt wurden, und sie beziehen sich auf den korrekten Gebrauch vom Terminal.

### NORM FÜR DIE LASERSICHERHEIT

Dies Produkt entspricht am Tag der Herstellung den gültigen EN 60825-1:2001 und CDRH 21 CFR 1040 Subchapter J Normen für die Lasersicherheit.

Es ist nicht notwendig, das Gerät wegen Betrieb oder Installations-, und Wartungs-Arbeiten zu öffnen.



**ACHTUNG**

*Unter keinen Umständen darf versucht werden, die Komponenten im Optikhohlraum zu öffnen oder auf irgendwelche andere Weise zu warten. Das Öffnen bzw. Warten der Komponenten im Optikhohlraum durch unbefugtes Personal verstößt gegen die Laser-Sicherheitsbestimmungen. Das Optiksystm darf nur werkseitig repariert werden.*



**ACHTUNG**

*Jegliche Änderungen am Gerät sowie Vorgehensweisen, die nicht in dieser Betriebsanleitung beschrieben werden, können ein gefährliches Laserlicht verursachen.*

Der Produkt benutzt eine Laserdiode. Obwohl zur Zeit keine Augenschäden von kurzen Einstrahlungen bekannt sind, sollten Sie es vermeiden für längere Zeit in den Laserstrahl zu schauen, genauso wenig wie in starke Lichtquellen (z.B. die Sonne). Vermeiden Sie es, den Laserstrahl weder gegen die Augen eines Beobachters, noch gegen reflektierende Oberflächen zu richten.



**ACHTUNG**

*Die Verwendung von Optiksyste men mit diesem Scanner erhöht die Gefahr einer Augenbeschädigung. Zu optischen Instrumenten gehören unter anderem Ferngläser, Mikroskope, Brillen und Vergrößerungsgläser.*

## FRANÇAIS

Les informations suivantes sont fournies selon les règles fixées par les autorités internationales et se réfèrent à une correcte utilisation du terminal.

### NORMES DE SECURITE LASER

Ce produit est conforme aux normes de sécurité laser en vigueur à sa date de fabrication: CDRH 21 CFR 1040 sous-chapitre J et EN 60825-1:2001.

Il n'est pas nécessaire d'ouvrir l'appareil pour l'installation, l'utilisation ou l'entretien.



**ATTENTION**

*Ne pas essayer d'ouvrir ou de réparer les composants de la cavité optique. L'ouverture de la cavité optique ou la réparation de ses composants par une personne non qualifiée peut entraîner le non-respect des règles de sécurité relatives au laser. Le système optique ne peut être réparé qu'en usine.*



**ATTENTION**

*L'utilisation de procédures ou réglages différents de ceux donnés ici peut entraîner une dangereuse exposition à lumière laser visible.*

Le produit utilise une diode laser. Aucun dommage aux yeux humains n'a été constaté à la suite d'une exposition au rayon laser. Eviter de regarder fixement le rayon, comme toute autre source lumineuse intense telle que le soleil. Eviter aussi de diriger le rayon vers les yeux d'un observateur, même à travers des surfaces réfléchissantes (miroirs, par exemple).



**ATTENTION**

*L'utilisation d'instruments optiques avec le scanneur augmente le danger pour les yeux. Les instruments optiques comprennent les jumelles, les microscopes, les lunettes et les verres grossissants.*

## ESPAÑOL

Las informaciones siguientes son presentadas en conformidad con las disposiciones de las autoridades internacionales y se refieren al uso correcto del terminal.

### NORMATIVAS ESTÁNDAR PARA LA SEGURIDAD LÁSER

Este aparato resulta conforme a las normativas vigentes de seguridad láser a la fecha de producción: CDRH 21 CFR 1040 Sección J y EN 60825-1:2001.

No es necesario abrir el aparato para la instalación, la utilización o la manutención.



**ATENCIÓN**

*No intente abrir o de ninguna manera dar servicio a ninguno de los componentes del receptáculo óptico. Abrir o dar servicio a las piezas del receptáculo óptico por parte del personal no autorizado podría ser una violación a los reglamentos de seguridad. El sistema óptico se puede reparar en la fábrica solamente.*



**ATENCIÓN**

*La utilización de procedimientos o regulaciones diferentes de aquellas descritas en la documentación puede causar una exposición peligrosa a la luz láser visible.*

El aparato utiliza un diodo láser a baja potencia. No son notorios daños a los ojos humanos a consecuencia de una exposición de corta duración. Eviten de mirar fijo el rayo láser así como evitarían cualquiera otra fuente de luminosidad intensa, por ejemplo el sol. Además, eviten de dirigir el rayo láser hacia los ojos de un observador, también a través de superficies reflectantes como los espejos.



**ATENCIÓN**

*El uso de sistemas ópticos con el escáner aumentará el riesgo de daños oculares. Los instrumentos ópticos incluyen binoculares, microscopios, lentes y lupas.*

## **LED Illuminator**

The use of an illuminator in the Kyman™ Imager models is a Class 1 LED product:

CLASS 1 LED PRODUCT

ILLUMINATORE LED CLASSE 1

AUSLEUCHTER LED KLASSE 1

ILLUMINATEUR A LED DE CLASSE 1

ILUMINADOR LED DE CLASE 1

## **RADIO COMPLIANCE**

In radio systems configured with mobile computers and access points, the frequencies to be used must be allowed by the spectrum authorities of the specific country in which the installation takes place. Be absolutely sure that the system frequencies are correctly set to be compliant with the spectrum requirements of the country.

The Radio modules used in this product automatically adapt to the frequencies set by the system and do not require any parameter settings.

The following shows the correspondence between the Kyman™ models and the Radio modules:

- Kyman™ 7XX-XXX 802.11b/g (Wi-Fi) radio card
- Kyman™ X1X-XXX GSM/GPRS Tri-band (900,1800,1900 MHz) module
- Kyman™ X2X-XXX GSM/GPRS/EDGE Quad-band (800,900,1800,1900 MHz) module

## **Information for the User**

### **ENGLISH**

Contact the competent authority responsible for the management of radio frequency devices of your country to verify any possible restrictions or licenses required. Refer to the web site <http://europa.eu.int/comm/enterprise/rte/spectr.htm> for further information.

### **ITALIANO**

Contatta l'autorità competente per la gestione degli apparati a radio frequenza del tuo paese, per verificare eventuali restrizioni o licenze. Ulteriori informazioni sono disponibili sul sito:

<http://europa.eu.int/comm/enterprise/rte/spectr.htm>.

### **FRANÇAIS**

Contactez l'autorité compétente en la gestion des appareils à radio fréquence de votre pays pour vérifier d'éventuelles restrictions ou licences. Pour tout renseignement vous pouvez vous adresser au site web:

<http://europa.eu.int/comm/enterprise/rte/spectr.htm>.

## DEUTSCH

Wenden Sie sich an die für Radiofrequenzgeräte zuständige Behörde Ihres Landes, um zu prüfen ob es Einschränkungen gibt, oder eine Lizenz erforderlich ist. Weitere Informationen finden Sie auf der Web Seite:

<http://europa.eu.int/comm/enterprise/rte/spectr.htm>.

## ESPAÑOL

Contacta la autoridad competente para la gestión de los dispositivos de radio frecuencia de tu país, para verificar cualesquiera restricciones o licencias posibles requerida. Además se puede encontrar mas información en el sitio web:

<http://europa.eu.int/comm/enterprise/rte/spectr.htm>.



## **FCC COMPLIANCE**

Modifications or changes to this equipment without the expressed written approval of Datalogic could void the authority to use the equipment.

This device has been tested and found to comply with the limits for a CLASS A digital device, pursuant to Part 15 of the FCC Rules. These limits are designed to provide reasonable protection against harmful interference when the equipment is operated in a commercial environment. This equipment generates, uses, and can radiate radio frequency energy and, if not installed and used in accordance with the instruction manual, may cause harmful interference to radio communications. Operation of this equipment in a residential area is likely to cause harmful interference in which case the user will be required to correct the interference at his own expense.

FCC ID: U4G0016 for models with only 802.11b/g radio

FCC ID: U4G0050 for models with 802.11b/g radio and Bluetooth®

## **SAR COMPLIANCE**

This product has been tested and found to comply with the following standards:

- EN50360: product standard to demonstrate the compliance of mobile phones with the basic restrictions related to human exposure to electromagnetic fields (300 MHz – 3 GHz).
- EN50361: basic standard for the measurement of specific absorption rate related to human exposure to electromagnetic fields from mobile phones (300 MHz – 3 GHz).
- OET BULLETIN 65 SUPPLEMENT C: evaluating compliance with FCC guidelines for human exposure to radio frequency electromagnetic fields.
- Australian Radiation Protection And Nuclear Safety Agency (ARPANSA): radiation protection series publication No. 3: maximum exposure levels to radio frequency fields 3 KHz TO 300 GHz.

## **INDUSTRY CANADA COMPLIANCE**

Operation is subject to the following two conditions: (1) this device may not cause interference, and (2) this device must accept any interference, including interference that may cause undesired operation of the device.

The highest measured SAR level is 0.186 W/Kg.

## **PATENTS**

This product is covered by one or more of the following patents.

U.S. Patents Nos: 5,992,740; 6,512,218 B1; 6,808,114B1; 6,877,664B1;  
6,997,385B2;

7,102,116 B2; 7,282,688 B2; 7,387,246 B2; 7,468,499 B2.

European patents Nos: 681,257B1; 789,315B1; 999,514 B1; 1,128,315 B1;  
1,172,756 B1 1,396,811 B1; 1,413,971 B1.



## WEEE COMPLIANCE



### Informazione degli utenti ai sensi della Direttiva Europea 2002/96/EC

L'apparecchiatura che riporta il simbolo del bidone barrato deve essere smaltita, alla fine della sua vita utile, separatamente dai rifiuti urbani.

Smaltire l'apparecchiatura in conformità alla presente Direttiva consente di:

- evitare possibili conseguenze negative per l'ambiente e per la salute umana che potrebbero invece essere causati dall'errato smaltimento dello stesso;
- recuperare materiali di cui è composto al fine di ottenere un importante risparmio di energia e di risorse.

Per maggiori dettagli sulle modalità di smaltimento, contattare il Fornitore dal quale è stata acquistata l'apparecchiatura o consultare la sezione dedicata sul sito [www.mobile.datalogic.com](http://www.mobile.datalogic.com).

### Information for the user in accordance with the European Commission Directive 2002/96/EC

At the end of its useful life, the product marked with the crossed out wheeled wastebin must be disposed of separately from urban waste.

Disposing of the product according to this Directive:

- avoids potentially negative consequences to the environment and human health which otherwise could be caused by incorrect disposal
- enables the recovery of materials to obtain a significant savings of energy and resources.

For more detailed information about disposal, contact the supplier that provided you with the product in question or consult the dedicated section at the website [www.mobile.datalogic.com](http://www.mobile.datalogic.com).

### Information aux utilisateurs concernant la Directive Européenne 2002/96/EC

Au terme de sa vie utile, le produit qui porte le symbole d'un caisson à ordures barré ne doit pas être éliminé avec les déchets urbains.

Éliminer ce produit selon cette Directive permet de:

- éviter les retombées négatives pour l'environnement et la santé dérivant d'une élimination incorrecte
- récupérer les matériaux dans le but d'une économie importante en termes d'énergie et de ressources

Pour obtenir des informations complémentaires concernant l'élimination, veuillez contacter le fournisseur auprès duquel vous avez acheté le produit ou consulter la section consacrée au site Web [www.mobile.datalogic.com](http://www.mobile.datalogic.com).

### **Información para el usuario de acuerdo con la Directiva Europea 2002/96/CE**

Al final de su vida útil, el producto marcado con un símbolo de contenedor de basura móvil tachado no debe eliminarse junto a los desechos urbanos.

Eliminar este producto de acuerdo con la Directiva permite de:

- evitar posibles consecuencias negativas para el medio ambiente y la salud derivadas de una eliminación inadecuada
- recuperar los materiales obteniendo así un ahorro importante de energía y recursos

Para obtener una información más detallada sobre la eliminación, por favor, póngase en contacto con el proveedor donde lo compró o consultar la sección dedicada en el Web site [www.mobile.datalogic.com](http://www.mobile.datalogic.com).

### **Benutzerinformation bezüglich Richtlinie 2002/96/EC der europäischen Kommission**

Am Ende des Gerätelebenszyklus darf das Produkt nicht über den städtischen Hausmüll entsorgt werden. Eine entsprechende Mülltrennung ist erforderlich.

Beseitigung des Produkts entsprechend der Richtlinie:

- verhindert negative Auswirkungen für die Umwelt und die Gesundheit der Menschen
- ermöglicht die Wiederverwendung der Materialien und spart somit Energie und Ressourcen

Weitere Informationen zu dieser Richtlinie erhalten sie von ihrem Lieferanten über den sie das Produkt erworben haben, oder besuchen sie unsere Homepage unter [www.mobile.datalogic.com](http://www.mobile.datalogic.com).

# GENERAL VIEW

---



- A) Backlit display
- B) User programmable LED
- C) Speaker
- D) Good read LED
- E) Charging status and battery low warning LED
- F) Scan key
- G) Keyboard
- H) Microphone
- I) Laser safety label
- J) Product label
- K) Adjustable elastic strap with stylus holders
- L) Battery pack



- M) Trigger (Gun Version Only)
- N) Handle (Gun Version Only)



O) Data capture/Laser Output window



P) Communication/Charger/Headset connector

# 1 INTRODUCTION

---

## 1.1 KYMAN™ DESCRIPTION

The Datalogic Kyman™ rugged mobile computer is one of the key elements of Datalogic's mobile@work™ product family for logistic solutions.

Kyman™, thanks to the lightest weight of its category combined with one of the best ergonomics ever seen on the market, reduces the operators fatigue with no compromises in terms of reliability and robustness. Its sturdy outer casing with overmold protection has been designed to resist harsh environments, multiple drops, strong shocks, repetitive tumbles as well as sub-zero temperatures.

Available in both handheld and pistol-grip models, Kyman™ guarantees maximum flexibility thanks to the add-on handle. In fact, it is possible to insert or remove the handle by simply using a screwdriver, maintaining, at the same time, its industry standard performance for sealing and drop capabilities.

Kyman™ key features include fully integrated automatic data capture (1D bar code, 1D bar code & RFID HF-ISO tags, 1D & 2D bar codes & images), allowing codes to be read from near contact to several meters distance and simultaneous wireless communication capabilities (Bluetooth®, Wi-Fi, GSM/GPRS/EDGE).

Kyman™ system architecture is based on the “de-facto standard” combination of the fastest Intel X-Scale series processors coupled with the Windows CE 5.0 operating system and it is ready to satisfy the most demanding customer needs (i.e. allowing to expand its memory thanks to a Secure Digital standard slot).

Kyman™ provides 2 intuitive keyboard layouts, numeric/alphanumeric with backlight, able to fulfill 100% traditional text based applications (i.e. terminal emulation, through the DL-TCL-NET™ software client) as well as the most modern Web-based solutions (i.e. exploiting the Microsoft Internet Explorer through the DL Locked Web Browser™ application).

Kyman™ provides mobile professionals with the most relevant features needed to operate in demanding environments: reliability, ruggedness, drop resistance, long lasting batteries, flexible communication and efficient data capture.

## 1.2 AVAILABLE MODELS

The brand new Kyman™ is available in different models depending on the options it is equipped with. All options are listed below:

- data capture options: laser, imager, RfId, laser + RfId, laser extra-long range
- communication options: Wi-Fi 802.11b/g, GSM/GPRS, GSM/GPRS/EDGE, Bluetooth®,
- data entry options: alphanumeric keyboard, numeric keyboard

For further details about the Kyman™ models refer to the web site: <http://www.datalogic.com>.

## 1.3 PACKAGE CONTENTS

The Kyman™ package contains:

- 1 Kyman™ mobile computer
- 1 CD-ROM Datalogic SDK
- 1 CD-ROM Getting Started Disk only for Windows Mobile
- 1 stylus
- 1 user's manual
- 1 rechargeable battery pack
- 1 adjustable elastic strap with stylus holder (only handheld version)
- 1 belt clip (only handheld version)
- 1 belt clip pivot (only handheld version)
- 1 long strap (only gun version)
- 1 elastic strap for stylus
- 1 short strap for stylus (only gun version)

Other accessories, necessary for the Kyman™ connection to the host computer and to the network are sold separately: the cradle, power supply, and one or more connection cables.

Remove all the components from their packaging; check their integrity and congruity with the packing documents.



**CAUTION**

*Keep the original packaging for use when sending products to the technical assistance center. Damage caused by improper packaging is not covered under the warranty.*



**NOTE**

*Rechargeable battery packs are not initially charged. Therefore the first operation to perform is to charge them. See paragraph 4.1.*

### 1.3.1 Using the Belt Clip

To use the belt clip, proceed as follows:

1. Remove the elastic strap and unscrew the strap pivot.



2. Release the belt clip pivot by pressing the belt clip unlock button.

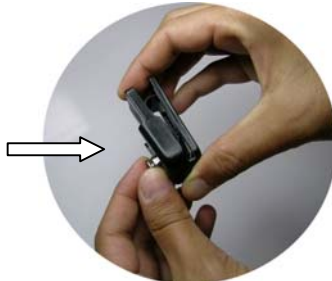

3. Screw the belt clip pivot on the terminal by using the fixing screw.





4. Insert the terminal in the belt clip by sliding the belt clip pivot into the belt clip until it clicks into place.



5. To release the terminal, press the belt clip unlock button.

## 1.4 HANDLE MOUNTING

- 1- Unscrew the A, B and C screws with a philips screwdriver and remove the cover of the handle connector socket.

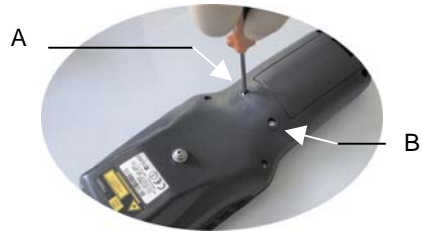

- 2- Insert the handle connector into the socket paying attention to the insertion key.



- 3- Fix the handle to the mobile computer body using the three screws included in the handle package.



### 1.5 INSTALLING THE SIM/SD CARD

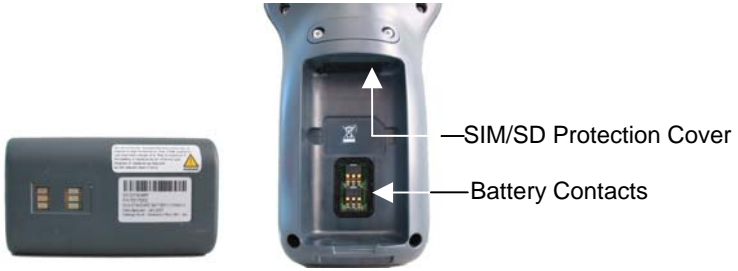

To correctly insert the SIM/SD Card, proceed as follows:

- 1- Turn off the Kyman™ mobile computer.
- 2- Pull the battery latch down as indicated in the next figure and remove the battery pack.



- 3- Open the Sim/SD Card slot with a tweezer

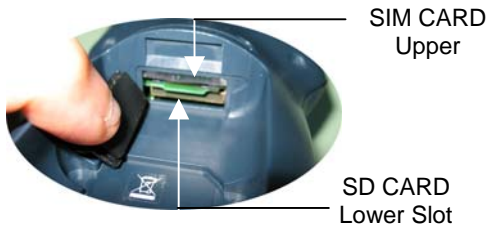

- 4- Insert the SIM CARD with the contacts downward and SD CARD with the contacts upward.



- 5- Push the cards into the slot using Datalogic Stylus until it clicks into place.

**CAUTION**

*Follow proper ESD precautions to avoid damaging the SIM/SD. Proper ESD precautions include, but are not limited to, working on an ESD mat and ensuring that the operator is properly grounded.*

*Do not force the card. If you feel resistance, remove the card, check the orientation, and reinsert it.*

*Do not use the SIM/SD card slot for any other accessories.*

### 1.5.1 Removing the SIM Card and SD-Card

To remove the SIM card and the SD-card, follow the steps above to access the SIM and SD-card area, and then follow the steps below:

- 1- To remove the SIM card and the SD card, just push them toward the inside, aided by the tip of the stylus, until they click; a spring system will return them out.

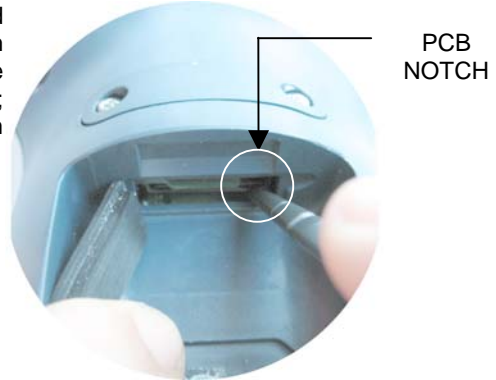
**NOTE**

*All the basic functionalities normally associated to the SIM card are managed by the terminal (GPRS connectivity, phone calls, SMS handling).*

*It is possible that not all the services connected to the SIM card can be used or can be managed by the terminal.*

## 1.6 ACCESSORIES

### ❑ Cradles

94A151101 Kyman™ Single Cradle Desk (includes slot for spare battery pack recharge; RS232 and USB communications)

94A151107 Kyman™ Vehicle Cradle

94A151115 Kyman™ Ethernet Desk Multi Cradle

### ❑ Charger

94A151102 Kyman™ Multi-Battery Pack Charger (4 slots)

### ❑ Batteries

94ACC1302 Kyman™ Standard Battery Pack (Li-Ion battery pack 2200 mAh@7.4 V)

### ❑ Power Supply

94ACC4595 FPS18 Power Supply without cord for Kyman™ Single Cradle Desk, for Kyman™ Multi-Battery Charger and for WIN-NET Serial/USB PWR Cables

94ACC1337 FPS19 W/O Power Cord, for Kyman™ Ethernet Desk Multi Cradle

94ACC1150 Power cord EU 3-pin

### ❑ Cables

94A051008 WIN-NET SERIAL CABLE (HRS 3500-16P-CV) cable for RS232 direct connection between the mobile computer and the PC

94A051009 WIN-NET USB CABLE (HRS 3500-16P-CV) cable for USB direct connection between the mobile computer and the PC

94A051014 WIN-NET SERIAL PWR CABLE (HRS 3500-16P-CV) cable for RS232 and power connections

94A051015 WIN-NET USB PWR CABLE (HRS 3500-16P-CV) cable for USB and power connections

94A051012 WIN-NET VEHICLE PWR CAB (HRS 3500-16P-CV) cable for car/truck cigarette lighter power adapter

### ❑ Various

94ACC1331 vo-CE® HEADSET

94ACC1332 vo-CE® HEADSET ADAPTER FOR Kyman™

94ACC1304 Kyman™ Belt Holster

94ACC1303 Kyman™ Functional Case

94ACC1301 Stylus Pen (20 pcs)

94ACC1343 Datalogic Kyman™ Backstrap Kit

94ACC1336 Kyman™ Gun Handle

**NOTE**

*Use only a Datalogic Mobile-approved power supply and cables. Use of an alternative power supply will invalidate any approval given to this device and may be dangerous.*

## 1.7 OPERATING SYSTEM

Datalogic Kyman™ comes in two different models, respectively supporting Windows CE and Windows Mobile.

For further information regarding Windows Mobile refer to the website: <http://www.microsoft.com/windowsmobile>.

## 2 CONNECTIONS

### 2.1 RS232/USB DIRECT CONNECTION

You can use a cable to connect the Kyman™ to a host computer to transfer data.



Key:

- |   |               |   |                          |
|---|---------------|---|--------------------------|
| A | Host computer | C | RS232 cable or USB cable |
| B | Kyman™        |   |                          |

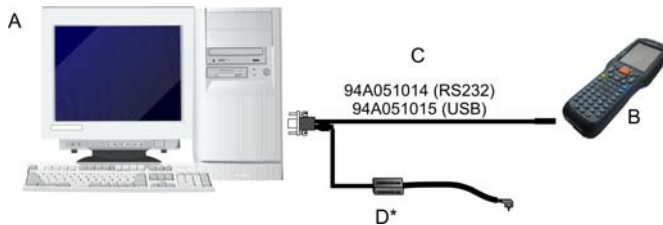

Key:

- |   |               |   |                          |
|---|---------------|---|--------------------------|
| A | Host computer | C | RS232 cable or USB cable |
| B | Kyman™        | D | Power Supply*            |

\* Recommended Power Supply: FPS18 AC/DC Power Supply (94ACC4595).



**CAUTION**

*If the PDA supports Windows Mobile, before plugging the RS232 cable you have to check the 'COM1 Enable' option on the 'System Configuration' window. (Start -> Programs -> System Configuration).*



**CAUTION**

*USB communication may not be completely guaranteed while batteries are simultaneously in charge. Avoid the power supply connection when the USB link is active.*



## 2.2 WLAN CONNECTION

Kyman™ Wi-Fi 802.11b and Wi-Fi 802.11b/g<sup>1</sup> models can communicate with the host using the on-board radio frequency module and an Access Point connected to the host computer.

For models using the WiFi7 radio (7xx-xxx-xxx models), you can find information about the applet for radio configuration: <http://www.summitdatacom.com/SCU.htm>.

To launch this utility you can tap the specific icon if it's visible on the taskbar or:

1. On Windows CE device, you can open Connections folder or Control Panel from desktop and select the 'Summit Client Utility' icon.
2. On Windows Mobile device, you can select the menu item: Start->Programs->Summit and tap the 'Summit Client Utility' icon.

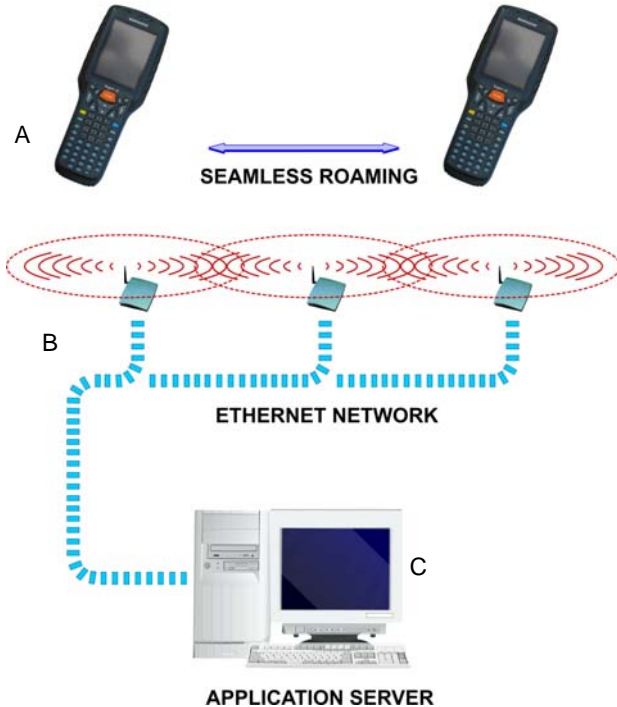

Key:

- A) Kyman™
- B) Access point
- C) Host – Application Server

<sup>1</sup> Note: unless otherwise specified, the Wi-Fi term is used both for the 802.11b and the 802.11b/g cards.

**NOTE**

*Wi-Fi module is on by default. In order to avoid wasting energy, you can switch it off using the Wireless Communications applet (see par. 3.8.4). To start configuring your WLAN connection, tap the Wi-Fi icon at the bottom of the screen.*

**NOTE**

*Suspending the terminal powers off the 802.11b/g radio and drops the radio connection. When the terminal resumes, depending on the radio power mode and security protocol selected, it takes approximately from 10 to 30 seconds for the 802.11b/g radio driver to re-associate the radio to the network.*

**NOTE**

*Area coverage and radio performance may vary, due to environmental conditions, access points types or interference caused by other devices (microwave ovens, radio transmitters, etc.).*

## 2.3 WPAN CONNECTIONS

Kyman™ mobile computers can communicate with a Bluetooth® device, such as a printer, within a range of 10 m, using the on-board Bluetooth® module.



Key:

- A) Kyman™
- B) Bluetooth® printer



NOTE

*In order to avoid wasting energy, the Bluetooth® module is off by default. If you need to have Bluetooth® working, the module must be powered on using the Wireless Communications applet (see par. 3.8.4), and perform the Discovery procedure (see par. 3.9.2).*



NOTE

*Suspending the terminal powers off the Bluetooth® radio and drops the piconet (Bluetooth® connection). When the terminal resumes, it takes approximately 10 seconds for the Bluetooth® radio driver to re-initialize the radio.*



NOTE

*Area coverage and Bluetooth® radio performance may vary, due to environmental conditions or interference caused by other devices (microwave ovens, radio transmitters, etc.), etc.*

## 2.4 WWAN CONNECTIONS

Kyman™ GSM/GPRS/EDGE models enhance your connectivity solutions giving you an opening to an international wireless infrastructure that is the standard in Europe and Asia.

GSM (Global System for Mobile communications), is a digital mobile phone system based on TDMA; it utilizes the 800, 900, 1800 and 1900 MHz bands.

GPRS supports IP (Internet Protocol) and allows accessing Internet and Intranet services, such as sending and receiving e-mail or Web browsing.

In order to use a WWAN Connection you have to install a SIM Card (see instructions on par. 1.5).

**NOTE**

*In order to avoid wasting energy, the GSM/GPRS module is off by default. If you need to have GSM/GPRS working, the module must be powered on using the Wireless Communications applet (see par. 3.8.4)*

**NOTE**

*Suspending the terminal powers off the GSM/GPRS radio and drops the connection.*

*When the terminal resumes, if the connection was managed by Microsoft Internet Explorer, it is automatically restored, otherwise, the radio connection must be manually re-initialized.*

**NOTE**

*The GSM voice capability of this mobile computer has to be addressed to occasional use, in well covered areas.*

*If the coverage is poor, the voice quality can be highly affected.*

*In case of vehicle cradle installations, a good habit is to install the external microphone to minimize the risk of noises and echoes.*

*If the coverage is poor, in case of continuous communication, some degradation of the barcode reading capabilities can be experienced.*

## 2.5 CRADLE CONNECTIONS

The Kyman™ can also communicate via RS232, USB and Ethernet, using various cradle models.

For further details, refer to the specific cradle model User's Manual.

## 2.6 CONNECTION CABLES

The following cables are listed with their order number.

### □ RS232 Direct Connection:

#### 94A051008 WIN-NET SERIAL CABLE (HRS 3500-16P-CV)

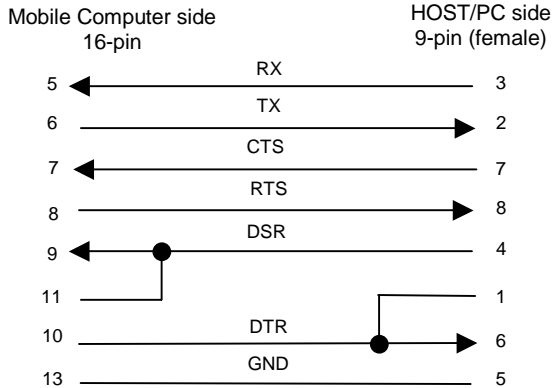

### □ USB Direct Connection:

#### 94A051009 WIN-NET USB CABLE (HRS 3500-16P-CV)

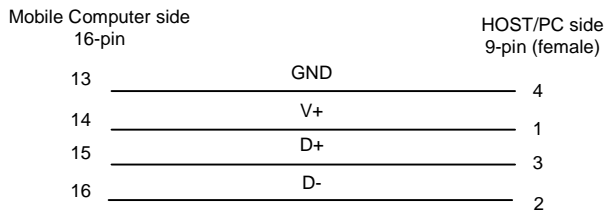

❑ **RS232 Direct Connection:**

**94A051014 WIN-NET SERIAL PWR CABLE (HRS 3500-16P-CV)**

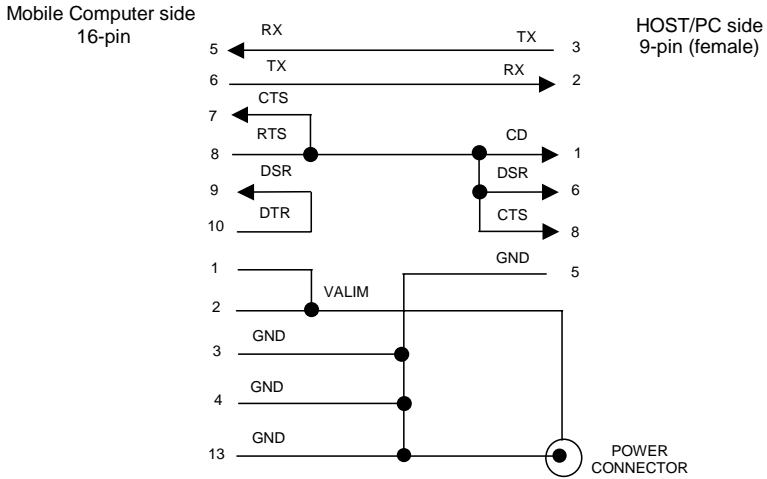

❑ **USB Direct Connection:**

**94A051015 WIN-NET USB PWR CABLE (HRS 3500-16P-CV)**

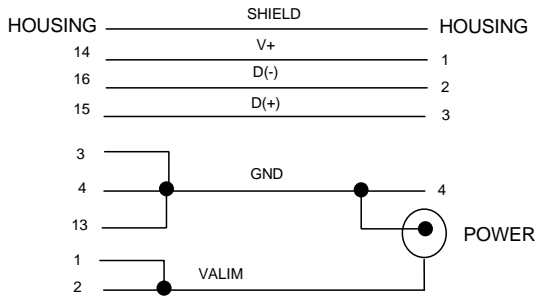

❑ **Power Supply Polarity:**

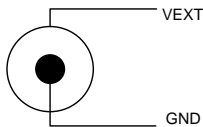

## 2.7 WIRELESS AND RADIO FREQUENCIES WARNINGS



### WARNING

*Use only the supplied or an approved replacement antenna. Unauthorized antennas, modifications or attachments could damage the product and may violate laws and regulations.*



### WARNING

*Most modern electronic equipment is shielded from RF signals. However, certain electronic equipment may not be shielded against the RF signals generated by the Kyman™.*



### WARNING

*Datalogic recommends persons with pacemakers or other medical devices to follow the same recommendations provided by Health Industry Manufacturers Associations for mobile phones.*

*Persons with pacemakers:*

- *Should ALWAYS keep this device more than twenty five (25) cm from their pacemaker and/or any other medical device;*
- *Should not carry this device in a breast pocket;*
- *Should keep the device at the opposite side of the pacemaker and/or any other medical device;*
- *Should turn this device OFF or move it immediately AWAY if there is any reason to suspect that interference is taking place.*
- *Should ALWAYS read pacemaker or any other medical device guides or should consult the manufacturer of the medical device to determine if it is adequately shielded from external RF energy.*

*In case of doubt concerning the use of wireless devices with an implanted medical device, contact your doctor.*



### WARNING

*Turn this device OFF in health care facilities when any regulations posted in these areas instruct you to do so. Hospitals or health care facilities may use equipment that could be sensitive to external RF energy.*



**WARNING**

*RF signals may affect improperly installed or inadequately shielded electronic systems in motor vehicles. Check with the manufacturer or its representative regarding your vehicle. You should also consult the manufacturer of any equipment that has been added to your vehicle.*

**WARNING**

*An air bag inflates with great force. DO NOT place objects, including either installed or portable wireless equipment, in the area over the air bag or in the air bag deployment area. If vehicle's wireless equipment is improperly installed and the air bag inflates, serious injury could result.*

**WARNING**

*Turn off the device when in any area with a potentially explosive atmosphere. Observe restrictions and follow closely any laws, regulations, warnings and best practices on the use of radio equipment near fuel storage areas or distribution fuel areas, chemical plants or where some operation involves use of explosive materials.*

*Do not store or carry flammable liquids, explosive gases or materials with the device or its parts or accessories.*

*Areas with a potentially explosive atmosphere are often, but not always, clearly marked or showed.*

*Sparks in such areas could cause an explosion or fire, resulting in injury or even death.*

## 3 USE AND FUNCTIONING

The use of the Kyman™ depends on the application software loaded. However there are several parameters that can be set and utilities that can be used to perform some basic functions such as data capture, communications, file management, etc.

### 3.1 STARTUP

To turn on the Kyman™, please insert a charged battery or connect the external supply.

If the mobile computer was left without any power for more than a few days, the bootstrap will start and the screen will appear as black for a few minutes. Please, be patient and wait a while. Once the bootstrap has been completed, you will see the Windows CE/ Windows Mobile desktop on the screen.

If instead the mobile computer was left without a power source for a smaller amount of time, it will resume to the status it had before the power was removed. In this case you will need to use the ON/OFF key to turn on the mobile computer.

As soon as the PDA is on, the Windows CE/ Windows Mobile desktop screen will appear. Wait a few seconds before starting any activity so that the PDA completes its startup procedure.

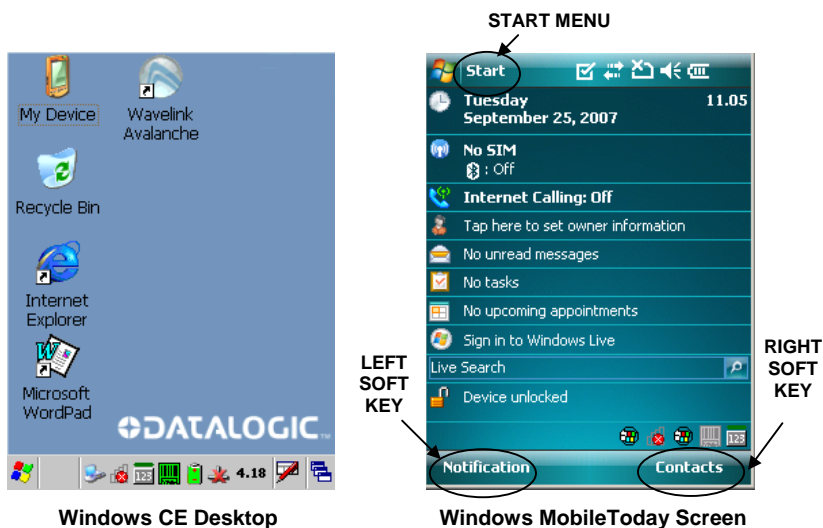

Use the stylus as suggested in paragraph 3.3 to select icons and options.

For the use of Left and Right Soft Keys, refer to par. 3.8.1.

The mobile computer goes into power-off (low power with display and keyboard backlight off), when it is no longer used for more than a programmable timeout, which is defined in the POWER applet of the Control Panel. In this mode it can be awakened (resuming operation) pressing any key.

**NOTE**

*The mobile computer can also be awakened or turned off by the application program.*

## 3.2 WINDOWS MOBILE WELCOME WIZARD

In Windows Mobile, at the very first Kyman™ startup, following a cold boot or following a registry restore to default values, the PDA startup (see par. 3.1) is preceded by the Welcome Wizard.



**Welcome Wizard Screen**

The Welcome Wizard allows the user to calibrate the touch screen (see par. 3.8.6) and to configure an email account and a password to protect the terminal.

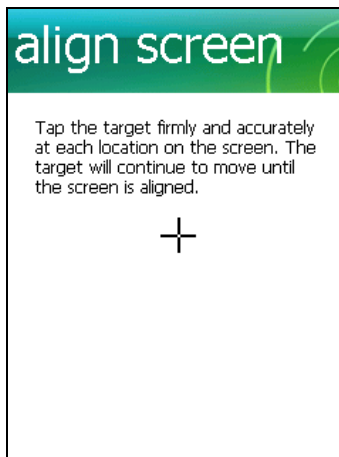

**Touch Screen Calibration Screen**

### 3.3 USING THE STYLUS

The stylus selects items and enters information. The stylus functions like a mouse.

<b>Tap:</b>	Touch the screen once with the stylus to open items and select options (Windows Mobile only).
<b>Double Tap:</b>	Touch the screen twice with the stylus to open items and select options (Windows CE only).
<b>Drag:</b>	Hold the stylus on the screen and drag across the screen to select text and images. Drag in a list to select multiple items.
<b>Tap-and-hold:</b>	Tap and hold the stylus on an item to see a list of actions available for that item. On the pop-up menu that appears, tap the action you want to perform.

To recalibrate the touch screen use the Stylus Applet (see par. 3.8.6).



**CAUTION**

*Use only original Datalogic styluses supplied with the product itself.*

*In harsh applications, use of screen protectors should be taken into consideration, in order to extend the touch screen operating life.*

*To prevent damage to the screen, do not use sharp devices or any device other than the Datalogic Mobile-provided stylus.*

*Do not apply not necessary high pressures on the screen.*

*For applications where an intensive use of the touch screen is foreseen, please consider that touch screen components are subject to progressive wear.*

## 3.4 DATA CAPTURE

To capture data first of all select the barcode icon on the bottom-right side of the display and tap the 'Capture' menu item, then proceed with the following directions. To configure and enable data capture parameters refer to par. 3.7.

### 3.4.1 Laser Data Capture

To scan barcodes, point the Kyman™ laser model onto the code from a distance within the reading range while pressing the SCAN key. See the reading diagrams in par. 5.2 for the reading range of your model.

The lighted band emitted by the laser must completely intercept the barcode as shown in the figure below. If enabled, the emission of an acoustic signal will indicate that the scan has taken place correctly.

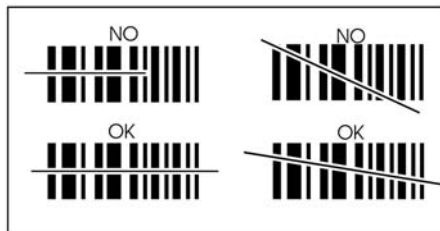
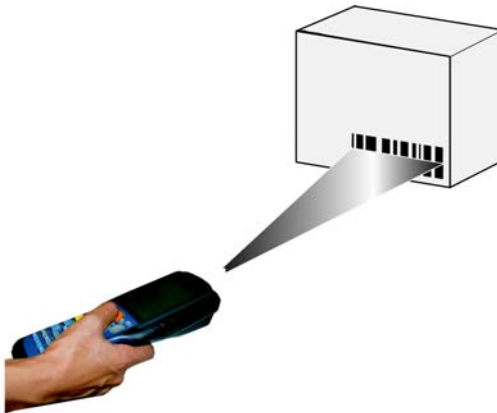

### 3.4.2 Imager Data Capture

To read a 1D or 2D code, simply point the Kyman™ Imager model onto the code from a distance within the reading range (See par. 5.1, section Kyman™ Imager Optical Features) and press the SCAN key.



The Kyman™ Imager uses an intelligent aiming system pattern similar to those on cameras, which indicates the field of view which should be positioned over the code:

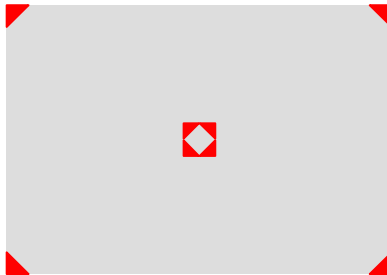

**Aiming System**

If the aiming system pattern is centered over the entire symbology as shown in the following figure, either wait for the timeout or release the Scan key to capture the image.

A red beam illuminates the code, which is captured and decoded. You will get a good read.

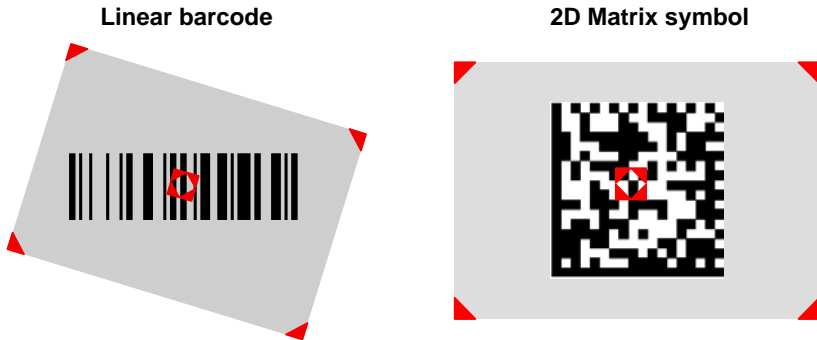

#### Relative Size and Location of Aiming System Pattern

The field of view changes its size as you move the reader closer or farther away from the code. The field of view indicated by the aiming system pattern will be smaller when the Kyman™ Imager is closer to the code and larger when it is farther from the code.

Symbologies with smaller bars or elements (mil size) should be read closer to the unit. Symbologies with larger bars or elements (mil size) should be read farther from the unit. (See par. 5.1 for further details).

### 3.4.3 RFID Data Capture

To read or write a tag, place the Kyman™ so that the RFID emission window is in front of and almost in contact with the tag, then press the SCAN key or the application defined key.





## 3.5 DESCRIPTION OF THE KEYS









The Kyman™ provides two different keyboards, an alphanumeric keyboard and a numeric keyboard, having a total of respectively 53 and 36 keys.

### 3.5.1 Alphanumeric Keyboard (53-key Model)

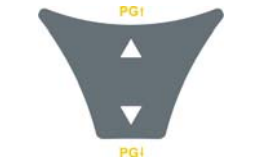



The following image shows the Alphanumeric keyboard.



## Main Keys Function

KEY	FUNCTION
 	<p>It starts data capture.</p> <p>They let you move forwards, backwards, upwards or downwards within text fields, scroll through a Menu list or browse among folder files.</p>
	<p>After a yellow modifier key press, they let you scroll the pages up and down.</p>
	<p>After a blue modifier key press, the blue arrows allow moving forwards or backwards within the Internet Explorer browser pages.</p>
	<p>Yellow modifier: when pressed before a standard key, it enables the function printed in yellow above the key.</p>
	<p>Blue modifier: when pressed before a standard key, it enables the function printed in blue above the key.</p>
	<p>After a yellow modifier key press, subsequent key presses allow the selection of seldom used characters. The selected character is entered after a short timeout or if a different key is pressed.</p>
	<p>It powers the Kyman™ ON or OFF.</p>
<p>Home</p>	<p>After a blue modifier key press, it allows returning to the Home page.</p>
<p>Stop</p>	<p>After a blue modifier key press, it allows ending a page downloading.</p>
<p>Refresh</p>	<p>After a blue modifier key press, it performs a page refresh.</p>

## Special Function Icons

ICON	FUNCTION
	After a yellow modifier key press, it opens the Start menu.
	After a yellow modifier key press, it opens the file manager.
	After a yellow modifier key press, it switches ON/OFF the keyboard backlight.
	After a yellow modifier key press, it locks and unlocks the keyboard.

### 3.5.2 Numeric Keyboard (36-key Model)



#### Main Keys Function



**KEY**

**FUNCTION**

It starts data capture.

They let you move forwards, backwards, upwards or downwards within text fields, scroll through a Menu list or browse among folder files.

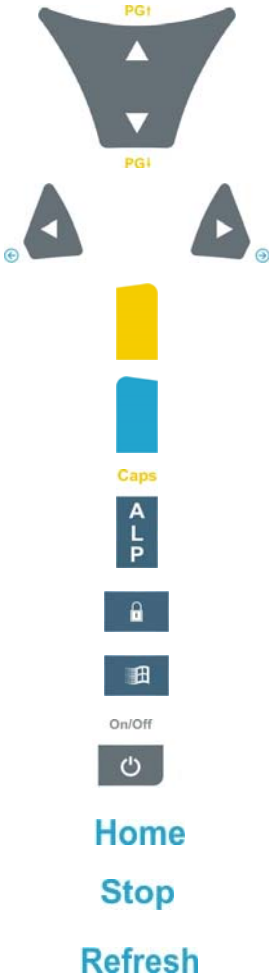

After a yellow modifier key press, they let you scroll the pages up and down.

After a blue modifier key press, the blue arrows allow moving forwards or backwards within the Internet Explorer browser pages.

Yellow modifier: when pressed before a standard key, it enables the function printed in yellow above the key.

Blue modifier: when pressed before a standard key, it enables the function printed in blue above the key.

When pressed, it toggles the alphanumeric/numeric modes.

It locks and unlocks the keyboard.

It opens the Start menu.

It powers the Kyman™ ON or OFF.

After a blue modifier key press, it allows returning to the Home page.

After a blue modifier key press, it allows ending a page downloading.

After a blue modifier key press, it performs a page refresh.



**NOTE**

*Once the Alpha mode has been entered, press the Alpha key again to exit this mode.*

Keys from 1 to 9 share the following behavior scheme:



- A. Function of the key when directly pressed
- B. Function of the key when in Alpha mode.  
When in Alpha mode press the key until the desired letter is shown.  
The letter is entered if you wait for a short timeout or if you press a different key.

## Special Function Icons

### ICON



### FUNCTION

It opens the file manager.

It switches ON/OFF the keyboard backlight.

### 3.5.3 Resetting the Kyman™

#### Windows CE

There are several reset methods for the Kyman™.

A warm boot terminates an unresponsive application and clears the working RAM, but preserves both the file system and the registry.

A cold boot forces all applications to close and clears working RAM and files not resident on the persistent flash memory. Registry is restored from persistent memory if available or returned to factory default.

A Clean Boot restores the Kyman™ to factory configuration: registry and file system return to factory default.

#### Warm Boot

A warm boot closes all applications, clears the working RAM, but preserves the file system and registry. If an application "hangs" initiate a warm boot to terminate the application.

To perform a warm boot, press these keys simultaneously:



#### Cold Boot

A cold boot is a complete reset of the Kyman™ in which all applications are forcibly closed and RAM is completely cleared. Registry is restored from persistent memory if a saved copy is available (see 3.8.2) and RAM file system completely erased. You will lose any applications and data (registry too) which are not stored in persistent flash memory.

A cold boot is necessary when the Windows CE operating system locks up and the warm boot command does not work.

To perform a cold boot, press these keys simultaneously:



#### Clean Boot

A clean boot is a cold boot that causes the device to be restored to factory configuration. The Kyman™ will reset to its factory configuration, clear the working RAM and initialize the file system. You will lose any applications and data stored in persistent flash memory. At the next startup the system will ask to recalibrate the touch screen.

To perform a clean boot, follow these steps:

1. Perform a Cold Boot (see Cold Boot).
2. Quickly release all the keys when the screen goes black.
3. Within 1 second press and hold down the Esc and 0 keys until the left orange led starts blinking.
4. Release the Esc and 0 keys.
5. Enter 1 to proceed with the Clean Boot sequence. Enter 0 to cancel the Clean Boot and proceed with a Cold Boot.

	<b>Warm Boot</b>	<b>Cold Boot</b>	<b>Clean Boot</b>
<b>Registry</b>	Preserved	Restored from flash (if available)	Factory default
<b>Flash Disk (Backup Folder)</b>	Preserved	Preserved	Clean disk
<b>RAM File System</b>	Preserved	Reinitialized (factory default)	Factory default



#### **CAUTION**

*Before performing a reset, it is recommended to:*

- *execute a system backup to keep your more important files and applications persistent. See par. 3.10;*
- *save the registry to non-volatile memory to guarantee the persistence of the Windows configuration. See par. 3.8.2.*

## **Windows Mobile**

There are several reset methods for the Kyman™.

A warm boot terminates an unresponsive application and clears the working RAM, but preserves the file system. Registry are restored from persistent memory if available or returned to factory default.

A cold boot forces all applications to close reinitializing completely the system. It clears the working RAM, but the file system is preserved. Registry are restored from persistent memory if available or returned to factory default.

A clean boot restores the Kyman™ to a clean configuration: both the registry and the file system return to a clean status that conform to factory default, unless the user has installed an additional package.

### **Warm Boot**

A warm boot closes all applications and clears the working RAM, but preserves the file system. Registry are restored from persistent memory if a saved copy is available (see Registry Applet, par. 3.8.2) or returned to factory default. If an application hangs, initiate a warm boot to terminate the application.

To perform a warm boot, press and hold the following keys simultaneously:





**Cold Boot**

A cold boot is a complete reset of the Kyman™ in which all applications are forcibly closed and the RAM is completely cleared. Registry is restored from persistent memory if a saved copy is available (see Registry Applet, par. 3.8.2). Applications and data stored on file system are preserved. A cold boot is necessary when the Windows Mobile operating system locks up and the warm boot command does not work.

To perform a cold boot, press and hold the following keys simultaneously:



**Clean Boot**

A clean boot is a cold boot that causes the device to be restored to a clean configuration. The Kyman™ will be reset to its factory configuration only if the user has not installed any additional package. Please note that you will lose any applications and data stored in persistent flash memory.

To perform a clean boot, follow these steps:

1. Perform a Cold Boot (see Cold Boot).
2. Quickly release all the keys when the screen goes black.
3. Within 1 second press and hold down the Esc and 0 keys until the left orange led starts blinking.
4. Release the Esc and 0 keys.
5. Enter 1 to proceed with the Clean Boot sequence. Enter 0 to cancel the Clean Boot and proceed with a Cold Boot.

	<b>Warm Boot</b>	<b>Cold Boot</b>	<b>Clean Boot</b>
<b>Registry</b>	Restored from flash	Restored from flash	Clean configuration (no user config)
<b>File System</b>	Preserved	Preserved	Clean Installation (no user files)

## 3.6 STATUS INDICATORS













### 3.6.1 LED Status

The Kyman™ provides three different LEDs signaling the mobile computer status.

LED	STATUS	
General Purpose (left-side)	Green/Red	This LED is available to the application program.
Charging Status and Battery Low Warning (right side)	Green constant	It is constant once the charging process has been completed.
	Red blinking	When the mobile computer is powered by the battery (not by the cradle nor by the cable), this LED blinks red to signal that the battery is running down.
	Red constant	It is constant while charging.
	Orange blinking	It blinks when a charging error has occurred, for example when a mobile computer <b>without battery</b> is connected to the external power or inserted into a powered cradle.
Good Read (middle)	Green	It is constant for a configurable time to signal that a successful read has occurred.

### 3.6.2 Taskbar

The Taskbar provides information about the time, the battery level, the keyboard function, and the decoding status.

ICONS	DESCRIPTION
<b>Time and Battery Icons</b>	
<b>10.50</b>	It displays the time.
	In Windows CE, they are representative of five different icons indicating the battery level. The icon is partially green when the power left is >20% and partially red colored when the power left is <20%.
	In Windows Mobile, it displays the system battery status.
	It indicates that the battery is charging (Windows CE).
	It shows the battery is charging (Windows Mobile).
<b>Keyboard Status Icons</b>	
	It indicates that the blue FUNC key has been pressed and is going to affect the next key press.
	It indicates that the yellow FUNC key has been pressed and is going to affect the next key press.
	It indicates that the keyboard is in ALPHA mode.
	It indicates that the keyboard is in Normal mode.
	It indicates that the keyboard is in ALPHA mode and that the Capslock is active.
	It indicates that the keyboard is locked.
<b>Decoding Status Icons</b>	
 	It indicates that the decoder is active (green), not active (grey).



**Windows CE Taskbar**



**Windows Mobile Taskbars**

### 3.7 DATA CAPTURE CONFIGURATION

From the Windows CE Taskbar, tap the "Decoding" icon to open a drop-down menu. Decoding can also be accessed from the Control Panel.

By selecting the *Info* item from this drop-down menu you can access information about the Scanner and the Software; the *Configure* item opens the configuration applet (Data Capture Configuration Window), while *Capture* accesses the data capture applet (Data Capture Window), which enables code reading.

The last menu item (*Wedge*) enables Wedge Emulation.

From the Windows Mobile Start menu, tap Settings -> System -> Data Capture. The "Data Capture" icon opens the configuration applet (Data Capture Configuration Window).

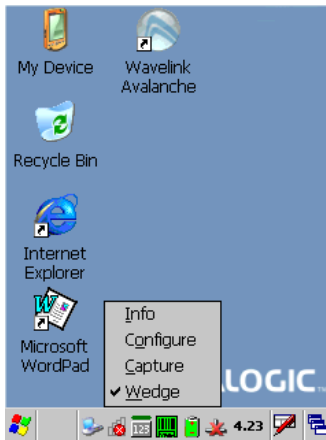

Windows CE

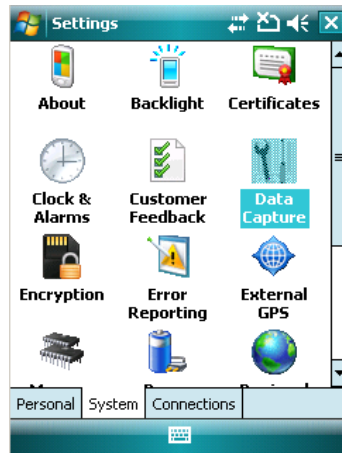

Windows Mobile

#### 3.7.1 Configure

The Configuration applet contains the barcode scanning configuration parameters in a directory tree structure. The available barcode parameters are divided into two groups: Reader Parameters and Scan Parameters.

The Reader Parameters depend on the type of scanner module installed on the mobile computer and allow barcode configuration (i.e. enable/disable Code 39, check digit control, etc.).



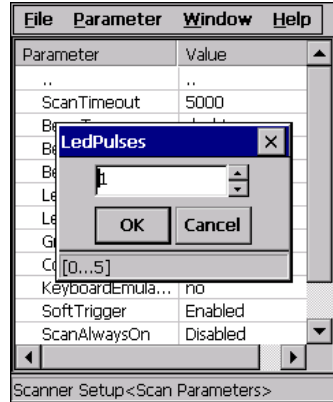
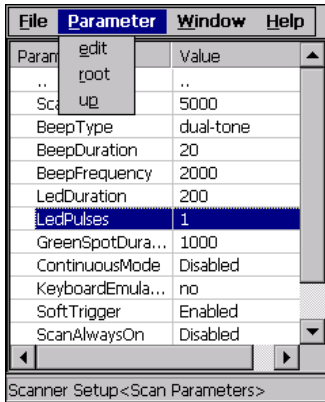

### Selecting Data Capture Setup Parameters

Alternatively using the stylus, you can tap once directly on the value on the right column; continue tapping until the desired value is reached.

To activate a new configuration select the File ->Save Menu to send the new configuration to the barcode decoding software and save the new configuration. This will save the configuration to non-volatile memory preventing loss at the next system reset.

## Reader Parameters

The barcode reading parameters and values are dependent upon the type of scanner module mounted in your mobile computer. For a detailed list of parameters and of their configuration procedures, please refer to the SDK Help file on the CD.

## Scan Parameters

The Scan Parameters are common to all scanner modules and allow control of the scanning device. The Scan parameters are described as follows:

**ScanTimeout:** the maximum time, in milliseconds, during which the scanner remains on without decoding any barcode.

**BeepType:** if set to dual tone, the good read beep is a sequence of high and low pitch sounds. If set to monotone, the beep is a single pitch sound.

**BeepDuration:** the time interval, in milliseconds, during which the beeper will sound when the scanner reads a code. To disable the beeper, set this value to 0.

**BeepFrequency:** determines the frequency in Hertz of the beeper.

**GoodReadSound:** is the filename of a .wav file played when the scanner reads a code.

**LedDuration:** the length of the good-read led pulse, in milliseconds.

**LedPulses:** the number of times the good-read led pulse is emitted when the scanner reads a code.

**GreenSpotDuration:** the length of the green spot pulse, in milliseconds

**ContinuousMode:** disables the effect of the ScanTimeout parameter.

**KeyboardEmulation:** if enabled all scanned data are transformed into keyboard events and can therefore be displayed and saved to a file as if input from the PDA keyboard. If set to "Yes (Clipboard)", it copies the scanned data to the system clipboard.

**SoftTrigger:** when enabled, the laser can be turned on/off by the application software.

**ScanAlwaysOn:** enables the scanner for barcode reading independently from the application software. If set to "Disabled after read", it disables the reading after a reading attempt. In case the scan button is accidentally pressed, this selection prevents the driver from decoding new data while the application is still elaborating previous data.



**NotPrintableChar:** if set to “Remove”, all not printable characters included in the scanned data are deleted and the final barcode will include only printable characters.

**ScanButton:** enables/disables the scan button. If the scan button is disabled, the reader can be triggered under software control.

## Default Settings

The following tables contain the default values for the major barcode setup parameters, according to the type of scan engine mounted on the mobile computer. For a complete list of parameters and of their configuration procedures, please refer to the SDK Help file on the CD.

SCAN PARAMETERS	Laser Models (XXX-1XX, XXX-4XX)	Imager Models (XXX-7XX)	Laser Extra Long Range Models (XXX-6XX)
ScanTimeout	5000	Not available	5000
BeepType	Dual tone	Dual tone	Dual tone
BeepDuration	20	20	20
BeepFrequency	2000	2000	2000
GoodReadSound	Beep.wav	Beep.wav	Beep.wav
LedDuration	200 mS	200 mS	200 mS
LedPulses	1	1	1
GreenSpot Duration	1000	1000	1000
ContinuousMode	Disabled	Disabled	Disabled
KeyboardEmulation	Enabled	Enabled	Enabled
SoftTrigger	Enabled	Enabled	Enabled
ScanAlwaysOn	Disabled	Disabled	Disabled
NotPrintableChar	Leave	Leave	Leave
ScanButton	Enabled	Enabled	Enabled

BARCODE SYMBOLOGY SPECIFIC READER PARAMETERS	Laser Models (XXX-1XX, XXX-4XX)	Imager Models (XXX-7XX)	Laser Extra Long Range Models (XXX-6XX)
UPC A	Enabled	*	Enabled
UPC E	Enabled		Enabled
EAN 8	Enabled		Enabled
EAN 13	Enabled		Enabled
UPC E1			Disabled
EAN Bookland			Disabled
UPC/EAN/JAN		Enabled	
Code 39	Enabled	Enabled	Enabled
Code 39 Full ASCII	Disabled	Disabled	Disabled
Code 32	Disabled		Disabled
Code 39 Trioptic			Disabled
2/5: Interleaved	Enabled	Enabled	Enabled
2/5: Industrial	Disabled		Disabled
2/5: Matrix	Disabled		
Code 128	Enabled	Enabled	Enabled
EAN 128	Enabled	Disabled	Enabled
ISBT 128			Disabled
Codabar	Enabled	Enabled	Disabled
RSS		Disabled	

\* In the Imager models these codes may only be enabled or disabled as a group by the UPC/EAN/JAN family selection (see a few lines below in the same table).

BARCODE SYMBOLOGY SPECIFIC READER PARAMETERS	Laser Models (XXX-1XX, XXX-4XX)	Imager Models (XXX-7XX)	Laser Extra Long Range Models (XXX-6XX)
MSI	Enabled		Disabled
Plessey	Disabled		
Code 93	Disabled	Enabled	Disabled
Code 11	Disabled		
PDF - 417		Enabled	
Data Matrix		Enabled	
QR		Enabled	
POSTNET		Disabled*	
PLANET			
Japan Post			
Australia Post			
KIX Code			
Royal Mail Code (RM4SCC)			

\* These codes may be enabled individually but are disabled as a group.



### 3.8 CONTROL PANEL

From the Windows CE Desktop, double tap on the "My Device" icon and then double tap on the "Control Panel" icon to open the Windows CE control panel main window. The Control Panel can also be launched from Start ->Settings ->Control Panel.

APPLET programs are displayed as icons; one icon corresponds to each APPLETT.

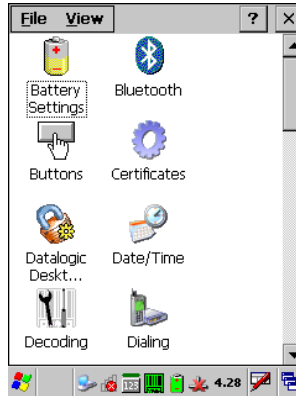

**Windows CE Control Panel**

From the Windows Mobile Start menu, tap Settings. A three tab dialog opens: Personal, System, Connections.

APPLET programs are displayed as icons; one icon corresponds to each APPLETT.



**Windows Mobile Control Panel**

### 3.8.1 Buttons

The BUTTONS Applet allows assigning desired applications to be launched by one of the function keys (F1, F2, F3, F4).

You can also select to wake up the terminal by the SCAN key and trigger key (for Datalogic Kyman-GUN™ only).



**Windows CE Buttons Icon**



**Buttons**

**Windows Mobile Buttons Icon**

On a Windows Mobile unit the user is also able to assign a shortcut to a function key. The default programs/shortcut assigned to the function keys on Windows Mobile are the following:

- F1 : select the Left Soft Key
- F2 : open the Start Menu
- F3 : open the Today Screen
- F4 : select the Right Soft Key

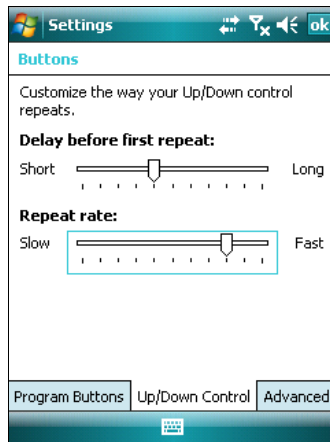

To configure the way up/down and the rest of keys control repeats, use the Up/Down Control applet (Start -> Settings -> Personal -> Buttons -> Up/Down Control).

### 3.8.2 Registry

The REGISTRY ADMIN applet provides management of Windows CE/ Windows Mobile registry.

From the Windows CE control panel main window, select the REGISTRY ADMIN applet by double tapping the Registry Admin icon.

From the Windows Mobile Start menu, tap Settings -> System ->Registry. Select the REGISTRY ADMIN applet by tapping the Registry Admin icon.

The Registry Administration Main window appears. Two functions are available:

- Save Registry allows permanently saving the Windows configuration (example: custom configuration of screen desktop background color, or network adapter configuration) to non-volatile memory (SAVE button).
- Restore Default Registry allows restoring the initial factory default configuration (Restore Default button). After restoring the factory default configuration, you must perform a warm boot (see par. 3.5.3).

Saving the registry to non-volatile memory guarantees the persistence of the Windows configuration in case of battery pack replacement and in case of a cold boot.

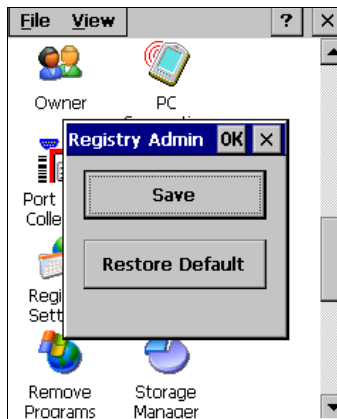

**Registry Administration Window**

### 3.8.3 Files Admin

The FILES ADMIN applet enables control of the permanence of files in the Windows CE System Folder.

Because Windows Mobile mounts the entire file system in persistent store (rather than using RAM), it provides both users and applications with a reliable storage platform even in the absence of battery power. The FILES ADMIN applet is therefore not necessary.

Two functions are available on the Files Admin Main window by means of two buttons:

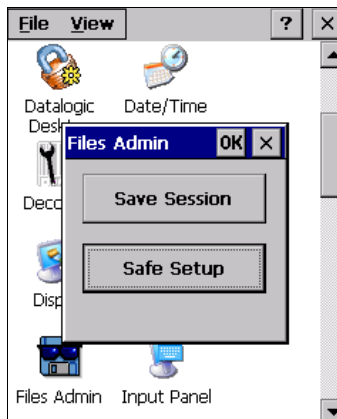

**Files Admin Main Window**

**Save Session:** with this button all files will be permanently saved in the \Windows directory in non-volatile memory. This function guarantees the steady maintenance of every file produced during the current working session - even of sub-directories and relevant files - with the exception of the files belonging to the FLASH image. These current working session files will be backed-up in the \Backup\Windows directory.

At the next cold boot, the files previously saved in the \Backup\Windows directory will be restored to the Windows directory (see par. 3.10).

**Safe Setup:** with this button, the installation of software programs will be saved to non-volatile memory (Backup directory). Before doing this, it will be checked that the Backup directory has enough space to save the files. If the directory space is not enough, an error message will be shown and the program will exit the Safe Setup function.

Two activating procedures are available for Safe Setup:

- Select an installation file (for example, a .CAB cabinet file) from the Safe Setup mask.

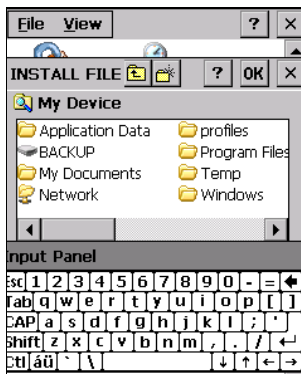

**Safe Setup First Mask**

Then select \Windows or a relevant sub-directory in the path box. Then, Safe Setup will recognize the new files and directories present in the \Windows directory, and will copy them to the \Backup\Windows directory. At the next cold boot, these files will be restored (see par. 3.10).

- Simply skip the first mask either by closing it or by pressing the ESC key. When it closes, a new mask will pop up: it will enable any type of installation (even remote ones like ActiveSync® installations). Make sure the installation directory is \Windows or one of its sub-directories. After installation, tap OK: Safe Setup will save the new files in the \Backup\Windows directory.

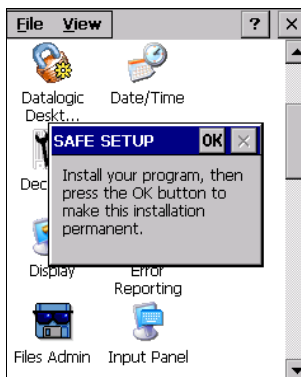

**Safe Setup Second Mask**



### 3.8.4 Wireless Communications

The WIRELESS COMMUNICATIONS applet provides management of the Wi-Fi Card, the Bluetooth® and GSM/GPRS modules.



**Windows CE Wireless Communications  
Icon**



**Windows Mobile Connectivity Icon**

If the PDA supports Windows CE, select the WIRELESS COMMUNICATIONS applet by double tapping the Wireless Communications icon. The following window will appear:

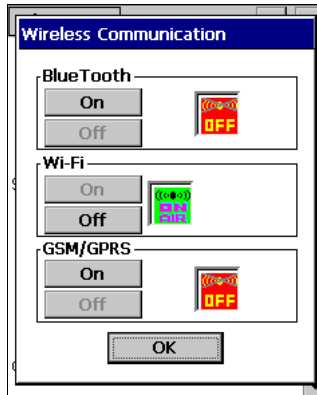

**Windows CE Wireless Communications Window**

If the PDA supports Windows Mobile, the Wireless Manager application manages access to wireless connections.

The 'Wireless Manager' is a sort of 'Control Panel' for Bluetooth® and phone modules. From here it's possible to turn on or off Bluetooth® and phone radio stacks. Open the Wireless Manager by tapping Start -> Settings -> Wireless Manager, or by tapping the Connectivity icon located at the top of the screen. The following window will appear:



**Windows Mobile Wireless Communications Window**

To turn on/off the WiFi radio open the Wi-Fi power applet by tapping Start -> Settings -> System -> Power -> Wi-Fi:

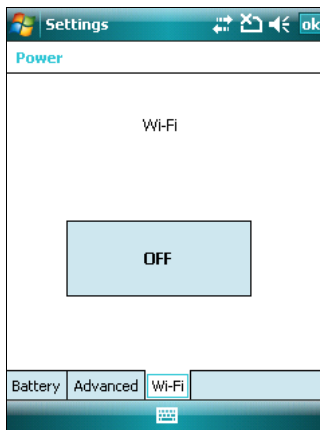

### 3.8.5 Ethernet Settings

#### Windows CE Ethernet Cradle

Datalogic Kyman™ can be connected to an Ethernet network by inserting it into the Datalogic Kyman™ Ethernet Multi Cradle.

When correctly inserted into the Ethernet Multi Cradle, the Ethernet driver installed on the mobile computer will automatically run, and using the DHCP service, will dynamically assign the IP Address.

1. From the Datalogic Kyman™ open Internet Explorer>Internet Options and check *use LAN no autodial* then OK.
2. From the Datalogic Kyman™ > Explorer, enter the IP address or the PC name in the address bar. You may be required to enter your network username and password. The LAN connection will take place and you will be able to see the PC shared folders and exchange files.

If your network provides Internet Service and does not use a proxy server you can directly access the Internet. Otherwise set the internet proxy parameters according to your network settings.

The LAN icon will appear on the Taskbar indicating the LAN connection status.

By double tapping on the LAN icon in the Taskbar, the LANNDS1 applet allows visualizing the TCP/IP information. Other information such as the MAC Address is available by tapping the Details... button.

If it is necessary to set static TCP/IP parameters, you must open the LANNDS1 applet from the Network and Dial-up Connections applet in the Control Panel. This applet is only visible when the mobile computer is correctly inserted into the Ethernet Multi Cradle.

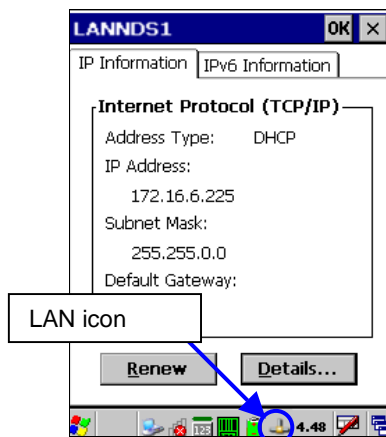

**Ethernet LANNDS1 Communications Window**

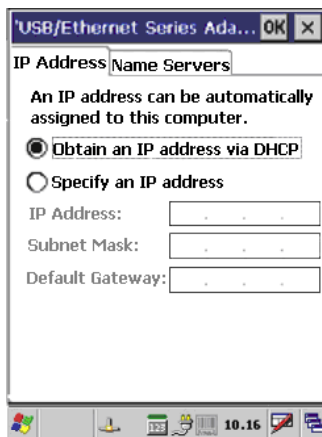

The IP Address belongs to Datalogic Kyman™ while the MAC address is specific to each cradle slot.

## Windows Mobile Ethernet Cradle

Before using the ethernet cradle you have to un-check the 'COM1 Enable' option on the 'System Configuration' window (Start -> Programs -> System Configuration) and re-boot the unit.

For internet browsing through the ethernet cradle ensure that programs that automatically connect to the internet should connect using 'My Work Network' -> go to Start -> Settings -> Connections -> Connections -> Advanced -> Select Networks:

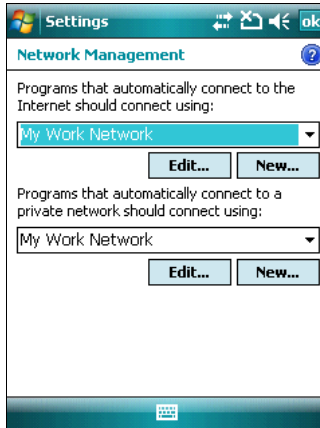

then ensure that the USB/Ethernet Adapter card connects to Work -> go to Start -> Settings -> Connections -> Connections -> Advanced -> Network Cards:

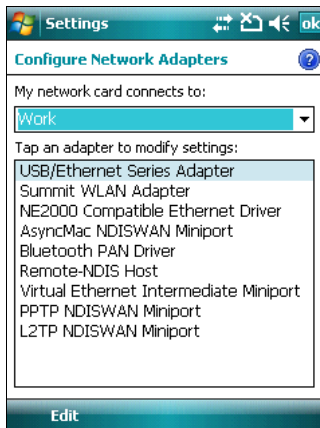

### 3.8.6 Stylus Calibration

You might need to recalibrate the touch screen (i.e. when you attempt to select one item with the stylus, another item is erroneously selected).

To recalibrate the touch screen on Windows CE, complete the following steps:

1. Select **Start > Settings > Control Panel > Stylus** to open the **Stylus Properties** dialog as shown in Figure 1.
2. Adjust **Double-Tap** sensitivity if needed or desired.
3. Select the **Calibration** tab to open the **Calibration** application.

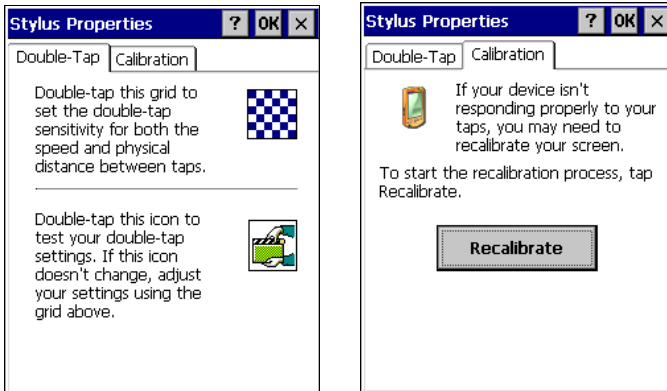

Figure 1

4. Tap **Recalibrate** to open the **Calibration** screen shown in Figure 2.
5. Carefully press and briefly hold stylus on the center of the target. Repeat as the target moves around the screen. Press the **<ESC>** key to cancel the stylus calibration.
6. Press the **<ENTER>** key or tap the screen to accept the new calibration settings. Press the **<ESC>** key to keep the old settings.
7. New calibration settings are persistently saved in registry.

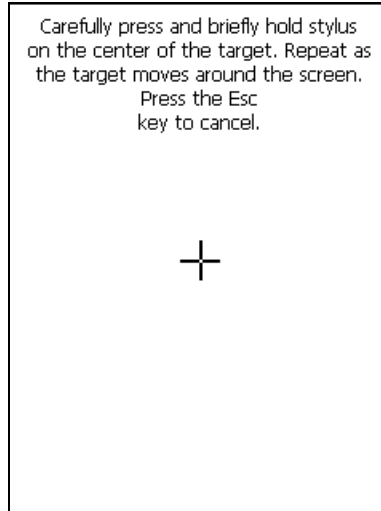

Figure 2

To recalibrate the touch screen on Windows Mobile, complete the following steps:

1. Select **Start > Settings > System > Screen** to open the **Screen Settings** dialog as shown in Figure 3.

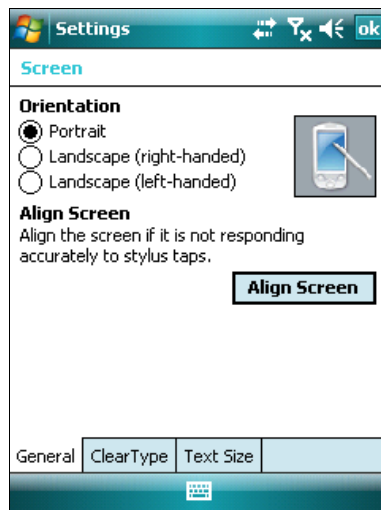

Figure 3

2. Tap **Align Screen** to open the **Calibration** screen shown in Figure 4.
3. Carefully press and briefly hold stylus on the center of the target. Repeat as the target moves around the screen. Press the **<ESC>** key at any time to cancel the stylus calibration.
4. By completing the calibration procedure you implicitly accept the new calibration settings.
5. New calibration settings are persistently saved in registry.

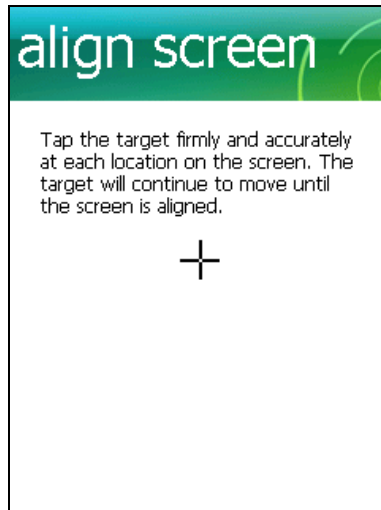

Figure 4



## Startup stylus calibration on Windows CE

When starting the terminal, a stylus calibration screen comes up if valid calibration settings are not available. This happens in the following circumstances:

1. At the first startup of the terminal.
2. After restoring registry default settings using the applet **Registry Admin** and performing a warm boot.
3. After a **Clean Boot**.
4. After a **Firmware Update** (see par. 3.11 ).

## Startup stylus calibration on Windows Mobile

When starting the terminal, a Welcome Wizard (with Stylus Calibration) comes up if valid calibration settings are not available. This happens in the following circumstances:

1. At the first startup of the terminal.
2. After restoring registry default settings using the applet **Registry Admin** and performing a boot.
3. After a **Clean Boot**.

### 3.8.7 Volume Settings

From the Windows CE control panel main window, select the VOLUME SETTINGS applet by double tapping the Volume Settings icon.

From the Windows Mobile Start Menu, tap Settings -> System -> Volume Settings. Select the VOLUME SETTINGS applet by tapping the Volume Settings icon.

The Volume Settings applet allows managing the audio features and appears as follows:

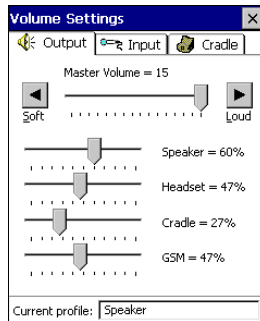

**Volume Settings Window**

The window is divided into three tabs:

- **Output** tab: allows setting the volume for each audio profile;
- **Input** tab: allows setting the microphone recording volume;
- **Cradle** tab: allows selecting the cradle type and managing the vehicle cradle headset functioning.

The Status bar always displays the current audio profile, which is activated automatically (by the device) or manually (by the user). Available profiles are:

- **Speaker**: it is the typical profile reproducing audio through the mobile computer speaker;
- **Cradle**: it is automatically activated as soon as the mobile computer is inserted into the vehicle cradle. Audio is reproduced by the vehicle cradle loudspeaker.
- **Headset**: it is automatically activated as soon as a headset is directly connected to the mobile computer. In case the device is inserted into the vehicle cradle and the headset is connected to the cradle, this profile must be manually activated through the dedicated button (refer to "Cradle Tab" paragraph). When this profile is active, the speaker does not work;

- **GSM:** it is automatically activated each time a phone-call is started. It is not available when using the cradle loudspeaker (in this case Current Profile = Cradle).

## Output Tab

It allows setting the volume for each audio profile:

The “Master Volume” slider allows setting the volume used by all audio profiles. In addition, it is possible to attenuate the volume for each single profile through the dedicated slider.

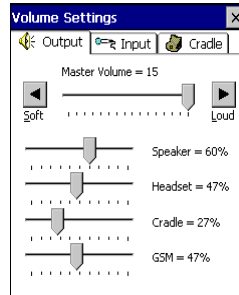

## Input Tab

It allows setting the microphone recording volume:

The “Record Gain” slider allows setting the recording volume, while the “Enable Preamplifier” check box enables/disables the preamplifier (this option is not selectable when Current Profile = Cradle or GSM).

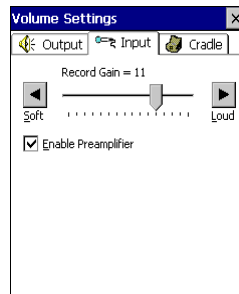

## Cradle Tab

It allows selecting the cradle type and managing the vehicle cradle headset functioning:

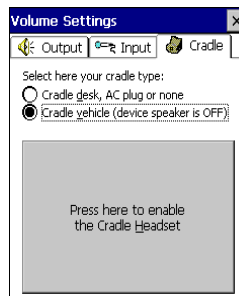
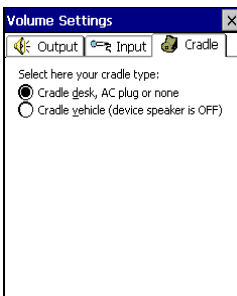

Two radio buttons allow selecting the type of cradle to be used.

Check the “Cradle desk, AC plug or none” radio button, if using a cradle different from the vehicle cradle or an AC adapter plug.

If using a vehicle cradle, check the related radio button.

**NOTE**

*By inserting the mobile computer into the cradle when the “Cradle vehicle” radio button is checked, the mobile computer speaker is deactivated and audio will be reproduced through the vehicle cradle speaker or headset.*

By selecting the “Cradle Vehicle” check box, a further button will appear allowing to enable the headset profile when using the vehicle cradle. If pressed, the button displays the headset icon in gray until the device is inserted into the vehicle cradle. Once inserted, the headset icon turns to green and the device activates the headset profile (refer to the following figures). Actually, the headset is ready to reproduce audio as soon as it is connected to the cradle jack:

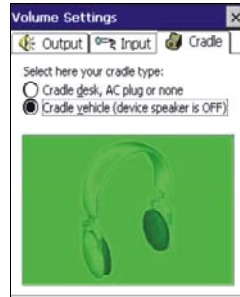
**WARNING**

*Do not use the vehicle cradle headset if the headset button is disabled, since it may cause hearing damage.*

## 3.9 WINDOWS CONNECTIONS

To connect Kyman™ to another device (i.e. Host PC) from Windows, several programs are available. These programs require specific electrical connections in order to function properly.

### 3.9.1 Microsoft® ActiveSync®

Microsoft® ActiveSync® gives you the possibility to connect your desktop computer to your Kyman™ and synchronize the information on them. Synchronization compares the data on the Kyman™ with that on the desktop computer and updates both computers with the most recent information.

With ActiveSync®, it is possible to:

- Back up and restore Kyman™ data.
- Copy files between Kyman™ and desktop computer.
- Synchronize files by selecting a synchronization mode.

You can establish an ActiveSync® connection to your Kyman™ through the following electrical interfaces:

**RS232** either directly or through the Kyman™ Single Cradle

**USB** either directly or through the Kyman™ Single Cradle

**Bluetooth®** (see par. 3.9.2)

It is possible to constantly synchronize while connected to a desktop computer or, alternatively, synchronization can be performed only when the synchronize command is chosen. You can select which information types are synchronized and control how much data is synchronized.



**NOTE**

*By default, ActiveSync® does not automatically synchronize all types of information. Use ActiveSync® options to turn synchronization on and off for specific information types.*

For example:

Synchronize Microsoft Word and Microsoft Excel files between the Kyman™ and the desktop computer. The files will automatically be converted to the correct format.

**NOTE**

*In Windows Mobile before using the ActiveSync follow the directions described in 2.1*

**NOTE**

*Visit the following Microsoft Web site for the latest in updates, technical information, and samples:  
<http://www.microsoft.com/windowsmobile/resources/downloads>*

## **ActiveSync® Remote**

**NOTE**

*Microsoft® ActiveSync® Remote is no longer supported in Windows CE. For backward compatibility you can download it from the internet. We suggest enabling the FTP Server and connecting to an FTP Client. See par. 3.9.3.*

## 3.9.2 Bluetooth® Manager Device Setup

### Windows CE Bluetooth® Manager Device Setup

In order to enable a Bluetooth® device for communication with the Kyman™ you must perform the discovery procedure and enable the device as follows:

1. Place the Bluetooth® device within the range of the Kyman™ (10 meters).
2. From the “Control Panel” main window double tap on the “Bluetooth” applet to open the Bluetooth® Manager Device window:



3. Tap on the “Me” button to enter the related window; then, tap on the “ON” button to activate the Bluetooth® module. The module activation may be also performed by using the WIRELESS COMMUNICATION applet as described in par. 3.8.4.

By tapping on the “HW Details” and “SW Details” buttons, information about the mobile computer Bluetooth® hardware and software will be displayed, while the “Enable Encryption” button starts encryption of the Bluetooth® communication data. If tapping on the “Close” button the Bluetooth® Manager Device window will be closed.

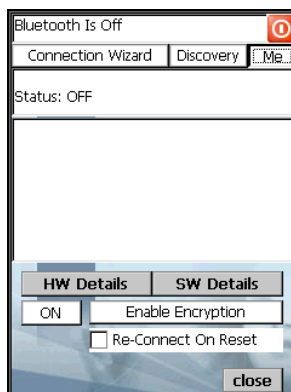



4. Tap on the “Discovery” button to enter the related window; then, tap on the “Scan” button to run the Discovery procedure.

Once the Discovery procedure has been completed, select the desired Bluetooth® device from the list. It is also possible to digit (12 hexadecimal digits) the Bluetooth® address of the desired device by tapping on the “Add” button. The “Clear” button deletes all discovered devices from the list.

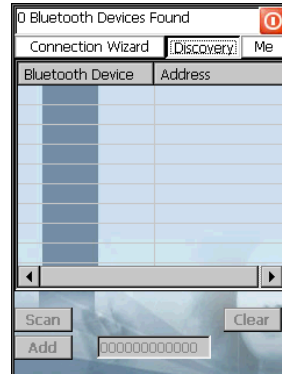

5. Once the desired Bluetooth® device has been selected, tap on the “Connection Wizard” button to enter the related window where selecting the connection type to be used for communication with the Bluetooth® device.

The “Serial Port” button starts communication through the Bluetooth® serial port COM 5 (typically used for connection with GPS devices).

The “Printer” button starts communication with a printer through the Bluetooth® serial port COM 5.

The “Kbd Emulation” button allows connection with a barcode reader using the keyboard emulation.

The “ActiveSync” button starts communication with a PC equipped with a Bluetooth® antenna and the related ActiveSync.



6. Hide the Bluetooth® Manager Device window by tapping on the  icon available on each window or close it through the “Close” button available in the “Me” window (see step 3 of this procedure).

## Windows Mobile Bluetooth® Manager Device Setup

Before turning on Bluetooth®, ensure that the two devices are within close range and that both Bluetooth®-enabled devices are discoverable.

1. Tap Start -> Settings -> Connections tab.
2. Tap Bluetooth > Mode
3. Select or clear the “Turn on Bluetooth” check box:

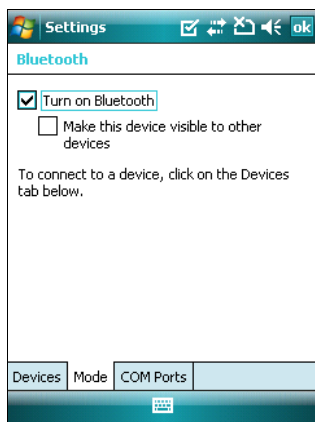

### NOTE

*By default, Bluetooth® is turned off. If you turn it on, and then turn off your device, Bluetooth® also turns off. When you turn on your device again, Bluetooth® turns on automatically.*

To create a Bluetooth® partnership between your device and another device that has Bluetooth® capabilities, ensure that the two devices are turned on, discoverable, and within close range.

1. Tap Start -> Settings -> Connections tab.
2. Tap Bluetooth -> Devices tab -> Add new devices. Your device searches for other devices with Bluetooth® capabilities, and displays them in the list:



3. Tap the name of the other device, and tap Next:

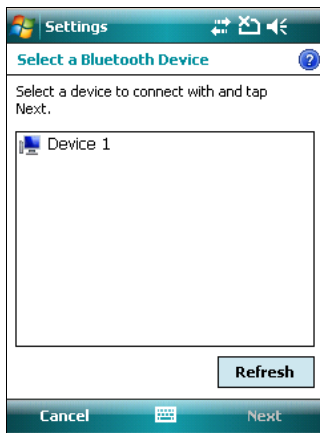

4. In Passkey, if you want to use a passkey (recommended for enhanced security), enter a alphanumeric passkey between 1 and 16 characters, and tap Next. Otherwise, leave the passkey blank, and tap Next:

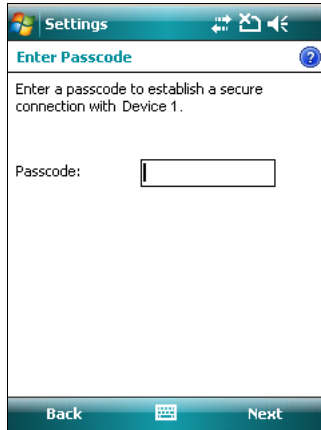

5. Enter the same passkey on the other device.
6. To give the partnership a more meaningful name, change the name of the device in Name.
7. Tap Finish.

You can give a more meaningful name to a Bluetooth® partnership to help you recognize it when selecting from a list of partnerships:

1. Tap Start -> Settings -> Connections tab.
2. Tap Bluetooth > Devices tab.
3. Tap the partnership to rename.
4. In Name, enter a new name for the partnership.
5. Tap Finish.

To end a Bluetooth® partnership:

1. Tap Start -> Settings -> Connections tab.
2. Tap Bluetooth > Devices tab.
3. Tap and hold the partnership you want to end.
4. Tap Delete:

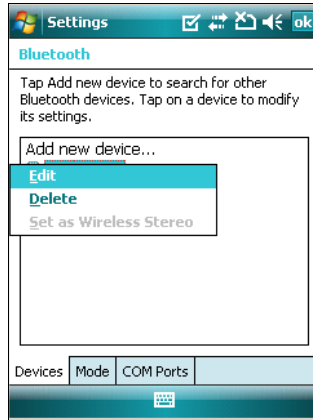

Other devices with Bluetooth® capabilities can detect your device and attempt to beam information to it, establish a partnership, or use a Bluetooth® service. To make a device discoverable:

1. Tap Start -> Settings -> Connections tab.
2. Tap Bluetooth > Mode Tab.
3. Select the “Turn on Bluetooth” check box, and then select the “Make this device visible to other devices” check box:

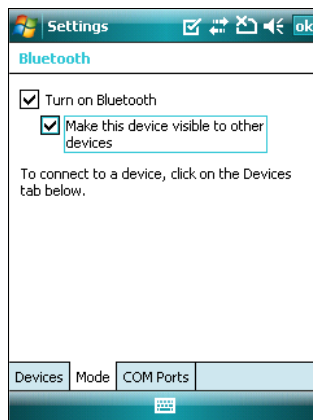

Other Bluetooth®-enabled devices can now detect your phone and attempt to beam information to it, establish a Bluetooth® partnership, or use a Bluetooth® service.

If you no longer want your device to be discoverable, clear the “Make this device visible to other devices” check box.

Your device will not detect and notify you of incoming Bluetooth® beams unless you set it up to do this. To receive a Bluetooth® beam:

1. Tap Start -> Settings -> Connections tab -> Beam:

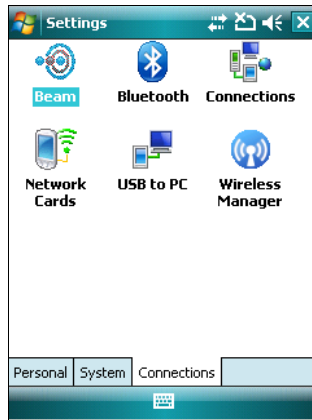

2. Select the “Receive all incoming beams” check box:

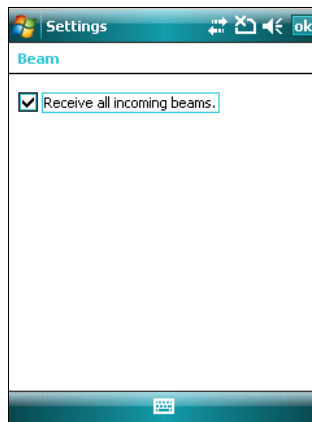

3. Ensure that your device is turned on, discoverable, and within close range of the device that is beaming the information.
4. When prompted to receive an incoming beam, tap “Yes” to receive the beamed information.

### 3.9.3 FTP Server Setup

The Kyman™ Operating System includes a sample File Transfer Protocol (FTP) server. FTP is used for copying files to and from remote computer systems over a network using TCP/IP. You can establish a connection to your Kyman™ using its FTP Server through the following interfaces:

**WLAN** using the WiFi radio

**LAN** through the Datalogic Kyman™ Ethernet Multi Cradle (see par. 3.8.5)

Proceed as follows:

1. Create a registry file (extension .reg) to setup and enable FTP Server communication. A simple example file for anonymous logon is given below:

```
REGEDIT4

[HKEY_LOCAL_MACHINE\Comm\FTPD]
"DefaultDir"="\\"
"AllowAnonymousUpload"=dword:00000001
"UseAuthentication"=dword:00000000
"BaseDir"="\\"
"IsEnabled"=dword:00000001
"LogSize"=dword:00001000
"DebugOutputMask"=dword:00000017
"DebugOutputChannels"=dword:00000002
"IdleTimeout"=dword:0000012c
"AllowAnonymous"=dword:00000001
"AllowAnonymousVroots"=dword:00000001
```

2. Copy this file to the Kyman™ using ActiveSync®.
3. Launch the .reg file from the Kyman™.
4. Perform a warm boot on the Kyman™.
5. From the PC > Explorer address bar (or running an FTP Client from the PC), enter the Kyman™ IP address.



**NOTE**

*For more information on FTP Client/Server connections refer to the following web page:*

*<http://msdn2.microsoft.com/en-us/library/ms901310.aspx>*

## 3.10 BACKUP DIRECTORY FILE MANAGEMENT

All of the Windows CE system files reside in RAM (volatile memory) except for the Backup directory, which resides in FLASH (non-volatile memory). Therefore the contents of the Backup directory are persistent even if the mobile computer is re-booted or the battery pack is changed.

You can save your more important files that you don't want to lose due to mobile computer re-boot, in the Backup directory or create a sub-directory within Backup.

Even though the Windows Directory resides in RAM, it often contains files or sub-directories created by the user or by installation programs that you don't want to lose at re-boot. To keep these files persistent it is necessary to copy them to the directory \Backup\Windows. This directory doesn't exist originally (only Backup exists), and therefore it must be created. At the next cold boot, before activating the shell, Windows CE will copy the contents including all sub-directories of \Backup\Windows to \Windows.

Likewise, to maintain files that must be run at Windows CE startup, (i.e. .exe, .lnk, .vb, .htm, etc.), it is necessary to copy them to the directory \Backup\Startup. This directory does not exist originally (only Backup exists), and therefore it must be created. The application programs will be run after any type of re-boot (both warm and cold boot).

As an alternative to the Safe Setup function, it is possible to copy the .cab files to the directory \Backup\Cabfiles (the Cabfiles sub-directory doesn't exist originally and must therefore be created) and perform a mobile computer cold boot to have the application installed. Once these files are copied to the directory \Backup\Cabfiles, the application will be run after each re-boot.

From the second cold boot on, a message may be displayed such as "<application name> is already installed. Re-install?". This message blocks the boot process. Press the [Enter] key to continue the system initialization.

Even if the entire Windows Mobile file system reside in FLASH (non-volatile memory), the mechanism described above is supported also on Windows Mobile for backward compatibility.



### **3.11 FIRMWARE UPDATE FOR WINDOWS CE**

The Datalogic Kyman™ is equipped with a tool that implements a firmware update service.

For further information, refer to DFU Reference Guide.

## 4 MAINTENANCE

---

**NOTE**

Rechargeable backup batteries and battery packs are not initially charged. Therefore the initial operation to perform is to charge them. See below.

**CAUTION**

By default, the battery pack is disconnected at the factory to avoid damage due to excessive draining.

Annual replacement of rechargeable battery pack avoids possible risks or abnormalities and ensures maximum performance.

### 4.1 CHARGING THE BATTERY PACK

**NOTE**

The battery pack autonomy varies according to many factors, such as the frequency of barcode scanning, RF usage, battery life, storage, environmental conditions, etc.

When the battery pack is low, the LED positioned at the right side of the display blinks orange.

It is possible to recharge the battery pack by using the FPS-18 AC/DC external power supply directly connected to the Kyman™, see par. 2.1.

Alternatively, it is also possible to recharge the battery pack by using the Kyman™ Single Cradle Desk or the Kyman™ Vehicle Cradle.

During the charging process the LED positioned at the right side of the display is red constant. Once the charging process has been completed this LED is green constant (see par. 3.6).

If the battery pack is removed from the mobile computer, it can be recharged by inserting it into the Kyman™ Multi-Battery Pack Charger.

**CAUTION**

*If the battery pack is new or has not been recharged for a long time, it is necessary to perform two or three charging and discharging cycles (complete use) before it can reach its maximum charge capability. The maximum time required to recharge a completely run-down battery pack is about 3 hours if the mobile computer is idling.*

**NOTE**

*Even if the storage temperature range is wider, In order to achieve the longest battery life, store the terminal and the spare batteries between 20 to 30 °C (68 to 86 °F). The Batteries must be charged at a temperature ranging from 0° to +45 °C (+32° to +113 °F).*

## 4.2 REPLACING THE BATTERY PACK

To correctly replace the battery pack, proceed as follows.

1. Turn off the Kyman™.
2. Pull the battery latch down as indicated in the figure below.



3. Remove the battery pack.

Battery Contacts



4. To correctly insert the new battery pack, first insert the bottom and then the upper part of the battery pack into the slot as indicated in the following figure:



5. Press it back until the battery latch is automatically closed.

**WARNING**

***Installing, charging and/or any other action should be done by authorized personnel and following this manual.***

*The battery pack may get hot, explode, ignite, and/or cause serious injury if exposed to abusive conditions.*

*If the battery pack is replaced with an improper type, there is risk of explosion.*

*Do not place the battery pack in or near a fire or heat; do not place the battery pack in direct sunlight, or use or store the battery pack inside unventilated areas in hot weather; do not place the battery pack in microwave ovens, dryer, high pressure containers, on induction cookware or similar device. Doing so may cause the battery pack to generate heat, explode or ignite. Using the battery pack in this manner may also result in a loss of performance and a shortened life expectancy.*

*Use only a Datalogic Mobile approved power supply. The use of an alternative power supply will void the product warranty, may cause product damage and may cause heat, explode or ignite.*

*The area in which the units are charged should be clear of debris and combustible materials or chemicals.*

*Do not use the battery pack of this terminal for power devices different from this mobile computer.*

*Immediately discontinue use of the battery pack if, while using, charging or storing the battery pack, the battery pack emits an unusual smell, feels hot, changes colour or shape, or appears abnormal in any other way.*

*Do not short-circuit the battery pack contacts connecting the positive terminal and negative terminal. This might happen, for example, when you carry a spare battery pack in your pocket or purse; accidental short-circuiting can occur when a metallic object such as a coin, clip, or pen causes direct connection of the contacts of the battery pack (these look like metal strips on the battery pack). Short-circuiting the terminals may damage the battery pack or the connecting object.*

*Do not apply voltages to the battery pack contacts.*

*Do not pierce the battery pack with nails, strike it with a hammer, step on it or otherwise subject it to strong impacts or shocks.*

**WARNING**

*Do not disassemble or modify (i.e. bend, crush or deform) the battery pack. The battery pack contains safety and protection devices, which, if damaged, may cause the battery pack to generate heat, explode or ignite.*

*In case of leakage of liquid from the battery, avoid contact with liquid the skin or eyes. If the contact occurs, immediately wash the affected area with water and consult a doctor.*

*Do not solder directly onto the battery pack.*

*Do not expose the battery pack to liquids.*

*Avoid any knocks or excessive vibrations. If the device or the battery is dropped, especially on a hard surface, you should take it to the nearest Authorised Repair Centre for inspection before continuing to use it.*

*Do not replace the battery pack when the device is turned on.*

*Do not remove or damage the battery pack's label.*

*Do not use the battery pack if it is damaged in any part.*

*Battery pack usage by children should be supervised.*

*Collect and recycle waste batteries separately from the device in comply with European Directive 2006/66/EC, 2002/95/EC, 2002/96/EC and subsequent modifications, US and China regulatory and others laws and regulations about environment.*

**NOTE**

*In order to guarantee an adequate operating autonomy, when replacing the battery pack the mobile computer checks the battery energy level. If the battery is not sufficiently charged, Kyman™ does not turn on (when pressing the ON button).*

*In this case, either substitute the battery pack with a charged one (sufficiently charged) or insert Kyman™ into a powered cradle or plug it into the direct power supply.*

**NOTE**

*To achieve the best battery life, turn off the radios not in use.*

### **4.3 CLEANING THE MOBILE COMPUTER**

Periodically clean the Kyman™ with a slightly dampened cloth.

Do not use alcohol, corrosive products or solvents.

## 5 TECHNICAL FEATURES

### 5.1 TECHNICAL DATA

#### Kyman™ Common Features

<b>Electrical Features</b>	
Power	
DC supply	14 V $\pm$ 5%
Battery pack	2 cell Li-Ion 2200 mAh @ 7.4 V (nominal)
Internal backup battery	Rechargeable Li-Ion 30 mAh
<b>Communication Features</b>	
Bluetooth® Interface	COM5
Serial interface	RS232 USB 1.1
<b>Windows CE COM Port</b>	
	COM1 COM6
<b>Wireless Features</b>	
WLAN	IEEE 802.11g DSSS
WPAN	Bluetooth® IEEE 802.15, Class 2, Version 1.2
WWAN	GSM/GPRS Tri-band (900, 1800, 1900 MHz) Radio with accessible SIM card interface* or GSM/GPRS7EDGE Quad-band (850, 900, 1800, 1900 MHz) Radio with accessible SIM card interface**
<b>Hardware Features</b>	
FLASH	128 MB
RAM	128 MB
Microprocessor	Intel XScale PXA 270 520 MHz
Audio	Speaker, Microphone, Buzzer
LED	Two-color Programmable LED Charging Status (two-color LED) Good Read LED
Display	64K Color TFT LCD with 320 x 240 pixel resolution, with LED backlight and touch screen
Keyboard	53 or 36 Plastic Top Backlit Keys
<b>Environmental Features</b>	
Working temperature***	-20° to + 50 °C / -4° to +122 °F
Storage temperature	-20° to +70 °C / -4° to +158 °F
Humidity****	90% non condensing for temperatures<40°C
Protection	IP64
ESD protection*****	4 KV contact discharge, 8 KV air discharge
Drop resistance*****	1.8 m / 6 ft



<b>Mechanical Features</b>	
Dimensions (LxWxH)	NO HANDLE : 23.8 x 9.1 x 5.5 cm / 9.3 x 3.5 x 2.2 in WITH HANDLE: 23.8 x 9.1 x 16.2 cm / 9.3 x 3.5 x 6.3 in
Weight (depending on model)	NO HANDLE: 550 - 630 g / 19.3 - 22.1 oz (incl. battery) WITH HANDLE: 660 - 690 g / 23.1 - 24.2 oz (incl. battery)

- \* 3,3 V compatible
- \*\* 3,3 V and 1,8 V compatible
- \*\*\* Close to the limits of the working temperature, some display and/or battery performance degradation may occur.
- \*\*\*\* Multiple rapid humidity and/or temperature variations may cause condensing.
- \*\*\*\*\* This device is designed and tested to withstand strong electrostatic discharges (ESD) and RF noise in order to work in harsh environments.  
When used in wired connections to a host computer, the host device must also be designed to withstand ESD and RF noise in order for the whole system to resist disturbance.
- \*\*\*\*\* Multiple drops can permanently damage the device.

<b>Programming Features</b>	
Operating system	Windows CE 5.0 Professional/ Windows Mobile 6 Professional
<b>Laser models</b>	
Decoded barcodes 1D	UPCA A, UPC E, EAN 8, EAN 13, Code 39, Code 39 Full ASCII, Code 32, Interleaved 2 of 5, Industrial 2 of 5, Matrix 2 of 5, Code 128, EAN 128, Codabar, MSI, Plessey, Code 93, Code 11
<b>RFID + Laser models</b>	
Operating frequency	13.56 MHz
Decoded barcodes 1D	UPC A, UPC E, UPC E1, EAN 8, EAN 13, EAN Bookland, Code 39, Code 39 Full ASCII, Code 32, Code 39 Trioptic, Interleaved 2 of 5, Industrial 2 of 5, Code 128, EAN 128, Codabar, MSI, Code 93
Decoded RFID Tags	Philips Mifare Classic 1k, EMS Mifare Classic 1k, Philips Classic 4k, EMS Mifare Classic 4k, Philips Mifare Ultralight, Philips I-Code Sli ISO15693, Texas Tag-It ISO15693, Infineon ISO15693, EMS ISO15693, Philips I-Code1, Fujitsu ISO15693
<b>Imager models</b>	
	UPC A, UPC E, EAN 8, EAN 13, UPC/EAN/JAN, Interleaved 2 of 5, Code 39, Code 39 Full ASCII, Codabar, Code 128, EAN 128, Code 93.
Decoded barcodes 2D	PDF417, DataMatrix, QR, MacroPDF, RSS.
Postal codes	POSTNET, PLANET, Japan Post, Australia Post, KIX Code, Royal Mail Code (RM4SCC)
<b>Laser Extra Long Range Models</b>	
Decoded barcodes 1D	UPC A, UPC E, UPC E1, EAN 8, EAN 13, Code 128, EAN 128, Code 39, Code 39 Full ASCII, Code 32, Code 93, Interleaved 2 of 5, discrete 2 of 5, Codabar, MSI, RSS

### Kyman™ Laser Optical Features

<b>Laser Optical Features</b>			
	<b>Kyman™ XXX-1XX Models</b>	<b>Kyman™ XXX-9XX Models</b>	<b>Kyman™ XXX-6XX Models</b>
Maximum resolution	0.13 mm / 5 mils	0.1 mm / 4 mils	0.2 mm / 7.5 mils
Skew angle	± 55°	± 65°	± 60°
Pitch angle	± 65°	± 50°	± 65°
Scan rate - horizontal	35 ± 5 scan/sec	105 ± 12 scan/sec	40 ± 6 scan/sec
Depth of field	See reading diagrams on the next page		
Light Source	VLD, wavelength 630–680 nm		
Laser Safety	Class II EN 60825-1/CDRH		

**Kyman™ Imager Optical Features (XXX-7XX models)**

<b>Imager Optical Features</b>			
Max. resolution			
1D Codes		0.10 mm / 4 mils	
2D Codes		0.17 mm / 6.6 mils	
Skew angle		± 40 °	
Pitch angle		± 35°	
Depth of field*			
<b>1D (linear):</b>	<b>X-dimension mm (mils)</b>	<b>Symbol size cm (in)</b>	<b>DOF cm (in)</b>
Code39	0.13 (5)	1.2 (0.47)	8.0 to 15.0 (3.15 to 5.90)
	0.50 (20)	3.2 (1.26)	8.0 to 33.0 (3.15 to 12.99)
EAN13	0.33 (13)	3.1 (1.22)	7.5 to 24.5 (2.95 to 9.65)
<b>2D:</b>	<b>X-dimension mm (mils)</b>	<b>Symbol size cm (in)</b>	<b>DOF cm (in)</b>
POSTNET	0.5 (20)	4.0 x 0.4 (1.57 x 0.16)	11.5 to 30.0 (4.53 to 11.81)
PDF417	0.13 (5)	1.1 x 0.9 (0.43 x 0.35)	8.5 to 15.5 (3.35 to 6.10)
	0.17 (6.6)	1.4 x 1.2 (0.55 x 0.47)	7.0 to 19.0 (2.76 to 7.48)
	0.25 (10)	2.2 x 1.8 (0.86 x 0.71)	4.5 to 24.0 (1.77 to 9.45)
QR	0.25 (10)	0.7 x 0.7 (0.28 x 0.28)	7.0 to 15.5 (2.76 to 6.10)
	0.38 (15)	1.1 x 1.1 (0.43 x 0.43)	4.5 to 21.0 (1.77 to 8.27)
DataMatrix	0.19 (7.5)	0.8 x 0.8 (0.31 x 0.31)	9.0 to 13.0 (3.54 to 5.12)
	0.25 (10)	0.8 x 0.8 (0.31 x 0.31)	7.5 to 16.5 (2.95 to 6.50)
	0.38 (15)	1.0 x 1.0 (0.39 x 0.39)	6.0 to 22.0 (2.36 to 8.66)
Sensor	640 x 480 pixel element, 2D CMOS array		
Illuminator	LED array		
Wavelength	630~670 nm		
LED Safety class	Class 1 to EN 60825-1		
Aiming System	Visible Laser Diode		
Wavelength	650 nm		
Laser Safety	Class 2 EN 60825-1; Class II CDRH		

\* Reading distances are measured from the nose of the reader using the test codes. The reading performances may vary depending on the code printing quality.

## 5.2 READING DIAGRAMS

### Kyman™ Laser (XXX-9XX models)

Reading Zones (10° skew angle)

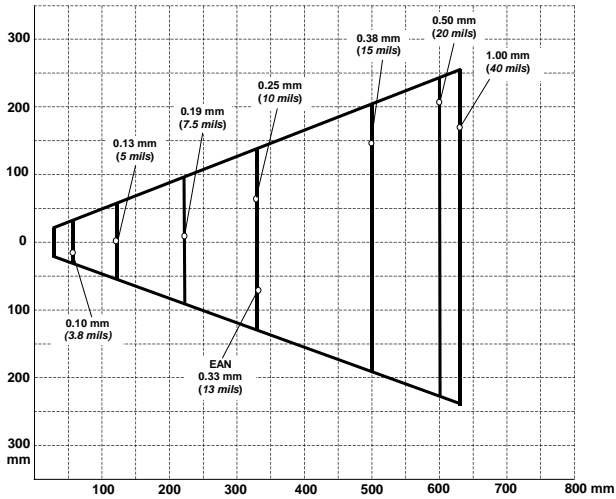

### Kyman™ HP Laser (XXX-1XX models)

Reading Zones (10° skew angle)

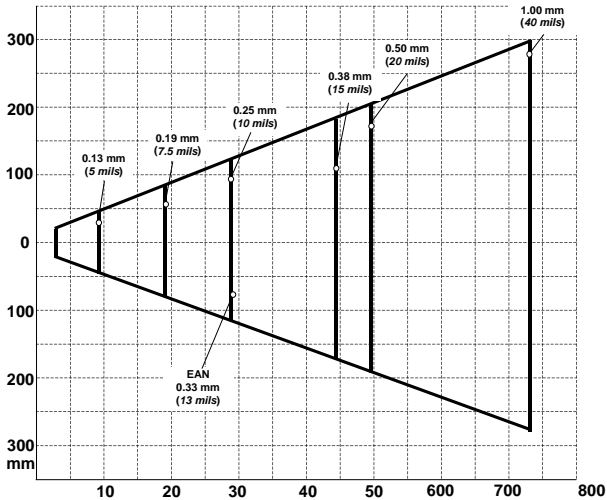

### Kyman™ XLR (XXX-6XX models)

Reading Zones (10° skew angle)

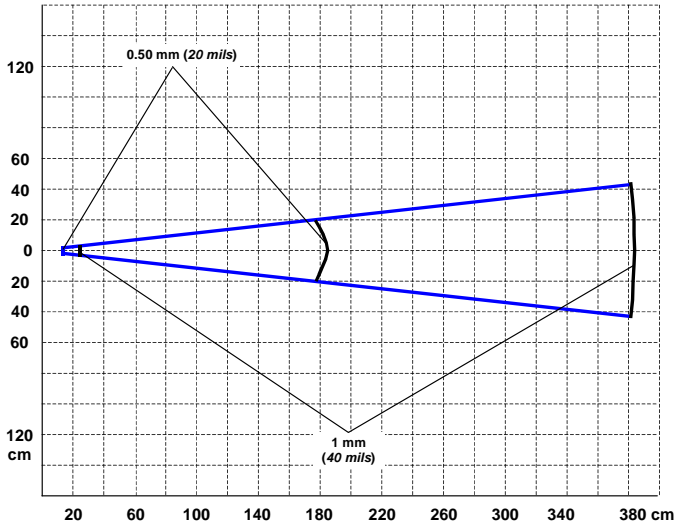

## 6 TEST CODES

---

### High Density Codes

0.25 mm (10 mils)

Code 39



17162

2/5 Interleaved



0123456784

Code 128



test

---

EAN 13

80%



8 012345 000012

EAN 8

80%



6450 9723

**Medium Density Codes**

0.38 mm (15 mils)

Code 39



17162

Interleaved 2/5



0123456784

Code 128



test

---

EAN 13



100%

8 012345 000012

EAN 8



100%

6450 9723

## Low Density Codes

0.50 mm (20 mils)

Code 39



17162

Interleaved 2/5



0123456784

Code 128



test

EAN 13

120%



8 012345 000012

EAN 8

120%



6450 9723



# GLOSSARY

---

## **Access Point**

A device that provides transparent access between Ethernet wired networks and IEEE 802.11 interoperable radio-equipped mobile units. Hand-held mobile computers, PDAs or other devices equipped with radio cards, communicate with wired networks using Access Points (AP). The mobile unit (mobile computer) may roam among the APs in the same subnet while maintaining a continuous, seamless connection to the wired network.

## **Barcode**

A pattern of variable-width bars and spaces which represents numeric or alphanumeric data in binary form. The general format of a barcode symbol consists of a leading margin, start character, data or message character, check character (if any), stop character, and trailing margin. Within this framework, each recognizable symbology uses its own unique format.

## **Baud Rate**

A measure for data transmission speed.

## **Bit**

Binary digit. One bit is the basic unit of binary information. Generally, eight consecutive bits compose one byte of data. The pattern of 0 and 1 values within the byte determines its meaning.

## **Bluetooth®**

A standard radio technology using a proprietary protocol. The onboard Bluetooth® module in the mobile computer is compatible with the 1.1 protocol.

## **Byte**

On an addressable boundary, eight adjacent binary digits (0 and 1) combined in a pattern to represent a specific character or numeric value. Bits are numbered from the right, 0 through 7, with bit 0 the low-order bit. One byte in memory can be used to store one ASCII character.

## **Decode**

To recognize a bar code symbology (*e.g.*, Codabar, Code 128, Code 3 of 9, UPC/EAN, etc.) and analyze the content of the bar code scanned.

**EDGE**

Enhanced Data rates for GSM Evolution, EDGE is a wireless packet-based communication service based on GSM. Its data transfer can reach a theoretical maximum of 473.6 Kbps.

**EEPROM**

Electrically Erasable Programmable Read-Only Memory. An on-board non-volatile memory chip.

**Flash Disk**

Non-volatile memory for storing application and configuration files.

**GPRS**

General Packet Radio Service. GPRS is a wireless packet-based communication service based on GSM. Its data transfer is rated between 56 Kbps to 114 Kbps. It makes very efficient use of available radio spectrum, and users pay only for the volume of data sent and received.

**GSM**

Global System for Mobile communication. It is a standard for digital cellular communications, currently used in the 900 MHz and 1800 MHz bands.

**Host**

A computer that serves other mobile computers in a network, providing services such as network control, database access, special programs, supervisory programs, or programming languages.

**Liquid Crystal Display (LCD)**

A display that uses liquid crystal sealed between two glass plates. The crystals are excited by precise electrical charges, causing them to reflect light outside according to their bias. They use little electricity and react relatively quickly. They require external light to reflect their information to the user.

**Light Emitting Diode (LED)**

A low power electronic light source commonly used as an indicator light. It uses less power than an incandescent light bulb but more than a Liquid Crystal Display (LCD).

**RAM**

Random Access Memory. Data in RAM can be accessed in random order, and quickly written and read.

**RF**

Radio Frequency

**RFID (Radio frequency identification)**

A technology that incorporates the use of electromagnetic or electrostatic coupling in the radio frequency (RF) portion of the electromagnetic spectrum to uniquely identify an object, animal, or person. RFID is coming into increasing use in industry as an alternative to the barcode identification.

## INDEX

---

### A

Accessories; 10  
Alphanumeric Keyboard; 29  
Available Models; 2

### B

Backup Directory File Management;  
76  
Belt Clip; 4  
Bluetooth® Approval; vi  
Bluetooth® Manager Device Setup;  
68  
Buttons; 49

### C

Charging the Batteries; 78  
Cleaning the Mobile Computer; 83  
Connection Cables; 18  
    RS232 Direct Connection; 18  
    RS232 Power Connection; 19  
    USB Direct Connection; 18  
    USB Power Connection; 19  
Connections; 12  
    RS232/USB Direct Connection; 12  
    WLAN Connection; 13  
    WPAN Connections; 15  
    WWAN Connections; 16  
Control Panel; 48  
Conventions; v  
Cradle Connections; 17

### D

Data Capture; 26  
    Imager Data Capture; 27  
    Laser Data Capture; 26  
    RFID Data Capture; 28  
Data Capture Configuration; 41  
**Default Settings**; 45  
Description of the Keys; 29

### E

Ethernet Settings; 55

### F

Files Admin; 51  
Firmware Update for Windows CE; 77  
FTP Server Setup; 75

### G

General View; xix  
Glossary; 93

### H

Handle; 6

### K

Kyman™ Description; 1

### M

Maintenance; 78  
Microsoft® ActiveSync®; 66

### N

Numeric Keyboard; 32

### O

Operating System; 11

### P

Package Contents; 2  
Patents; xvi

### R

Reader Parameters; 44  
Reading Diagrams; 88

Reference Documentation; v  
References; v  
Registry; 50  
Replacing the Batteries; 80  
Resetting the Kyman™; 35

## **S**

Safe Setup; 51  
Safety Regulations; vi  
    FCC Compliance; xv  
    Laser Safety; vii  
    Radio Compliance; xiii  
    SAR Compliance; xv  
    WEEE Compliance; xvii  
Save Session; 51  
Scan Parameters; 44  
Services and Support; v  
SIM/SD Card; 7  
Startup; 22  
Status Indicators; 38  
Stylus Calibration; 58

## **T**

Technical Features; 84  
Test Codes; 90

## **U**

Using the Stylus; 25

## **V**

Vocal Communication; 62  
Volume Settings; 62

## **W**

Windows CE Ethernet cradle; 55  
Windows Mobile Bluetooth® Manager  
    Device Setup; 70  
Windows Mobile Ethernet cradle; 57  
Windows Mobile Welcome Wizard; 24  
Wireless and Radio Frequencies  
    Warnings; 20  
Wireless Communication; 53

DATALOGIC MOBILE S.r.l.  
Via S. Vitalino, 13  
40012 - Lippo di Calderara  
Bologna - Italy



dichiara che  
declares that the  
déclare que le  
bescheinigt, daß das Gerät  
declare que el

**Kyman™ XXX-XXX**

e tutti i suoi modelli  
and all its models  
et tous ses modèles  
und seine Modelle  
y todos sus modelos

sono conformi alla Direttiva del Consiglio Europeo sottoelencata:  
are in conformity with the requirements of the European Council Directive listed below:  
sont conformes aux spécifications de la Directive de l'Union Européenne ci-dessous:  
der nachstehenden angeführten Direktive des Europäischen Rats entsprechen:  
cumple con los requisitos de la Directiva del Consejo Europeo, según la lista siguiente:

**1999/5/EEC R&TTE**

---

Questa dichiarazione è basata sulla conformità dei prodotti alle norme seguenti:  
This declaration is based upon compliance of the products to the following standards:  
Cette déclaration repose sur la conformité des produits aux normes suivantes:  
Diese Erklärung basiert darauf, daß das Produkt den folgenden Normen entspricht:  
Esta declaración se basa en el cumplimiento de los productos con las siguientes normas:

- ETSI EN 301 489-3 v1.4.1, August 2002:** ELECTROMAGNETIC COMPATIBILITY AND RADIO SPECTRUM MATTERS (ERM); ELECTROMAGNETIC COMPATIBILITY (EMC) STANDARD FOR RADIO EQUIPMENT AND SERVICES; PART 3: SPECIFIC CONDITIONS FOR SHORT-RANGE DEVICES (SRD) OPERATING ON FREQUENCIES BETWEEN 9 KHZ AND 40 GHZ
- ETSI EN 301 489-7 v1.2.1, August 2002:** ELECTROMAGNETIC COMPATIBILITY AND RADIO SPECTRUM MATTERS (ERM); ELECTROMAGNETIC COMPATIBILITY (EMC) CONDITIONS FOR MOBILE AND PORTABLE RADIO AND ANCILLARY EQUIPMENT OF DIGITAL CELLULAR RADIO TELECOMMUNICATIONS SYSTEMS (GSM AND DCS) OPERATING ON FREQUENCIES BETWEEN 9 KHZ AND 40 GHZ
- ETSI EN 301 489-17 v1.2.1, August 2002:** ELECTROMAGNETIC COMPATIBILITY AND RADIO SPECTRUM MATTERS (ERM); ELECTROMAGNETIC COMPATIBILITY (EMC) STANDARD FOR RADIO EQUIPMENT AND SERVICES; PART 17: SPECIFIC CONDITIONS FOR 2,4 GHZ WIDEBAND TRANSMISSION SYSTEMS AND 5 GHZ HIGH PERFORMANCE RLAN EQUIPMENT
- ETSI EN 301 511, March 2003:** GLOBAL SYSTEM FOR MOBILE COMMUNICATIONS (GSM); HARMONIZED EN FOR MOBILE STATIONS IN THE GSM 900 AND GSM 1800 BANDS COVERING ESSENTIAL REQUIREMENTS UNDER ARTICLE 3.2 OF THE R&TTE DIRECTIVE (1999/5/EC)

- ETSI EN 300 328 v1.6.1, November 2004:** ELECTROMAGNETIC COMPATIBILITY AND RADIO SPECTRUM MATTERS (ERM); WIDEBAND TRANSMISSION SYSTEMS; DATA TRANSMISSION EQUIPMENT OPERATING IN THE 2,4 GHz ISM BAND AND USING WIDE BAND MODULATION TECHNIQUES; HARMONIZED EN COVERING ESSENTIAL REQUIREMENTS UNDER ARTICLE 3.2 OF THE R&TTE DIRECTIVE
- ETSI EN 300 330-2 v1.1.1, June 2001:** ELECTROMAGNETIC COMPATIBILITY AND RADIO SPECTRUM MATTERS (ERM); SHORT RANGE DEVICES (SRD); RADIO EQUIPMENT IN THE FREQUENCY RANGE 9 KHZ TO 25 MHz AND INDUCTIVE LOOP SYSTEMS IN THE FREQUENCY RANGE 9 KHZ TO 30 MHz; PART 2: HARMONIZED EN UNDER ARTICLE 3.2 OF THE R&TTE DIRECTIVE
- EN 60950-1, December 2001:** INFORMATION TECHNOLOGY EQUIPMENT – SAFETY – PART 1: GENERAL REQUIREMENTS
- EN 50360, November 2001:** PRODUCT STANDARD TO DEMONSTRATE THE COMPLIANCE OF MOBILE PHONES WITH THE BASIC RESTRICTIONS RELATED TO HUMAN EXPOSURE TO ELECTROMAGNETIC FIELDS (300 MHz – 3 GHz)

Lippo di Calderara, 10/05/2007

  
Paola Chientaroli  
Quality Assurance Manager



[www.mobile.datalogic.com](http://www.mobile.datalogic.com)

**World wide Sales Network**  
**available from: [www.mobile.datalogic.com/contacts](http://www.mobile.datalogic.com/contacts)**

**Datalogic Mobile S.r.l.**

Via S. Vitalino, 13  
40012 Lippo di Calderara di Reno  
Bologna - Italy  
Telephone: (+39) 051-3147011  
Fax: (+39) 051-3147561

